

Dashing and Star: Byzantine Fault Tolerance Using Weak Certificates

Sisi Duan
Tsinghua University
Email: duansisi@tsinghua.edu.cn

Haibin Zhang*
Beijing Institute of Technology
Email: haibin@bit.edu.cn

Xiao Sui, Baohan Huang
Shandong University
Email: {suixiao, huangbaohan}@mail.sdu.edu.cn

Changchun Mu, Gang Di
Digital Currency Institute, the People's Bank of China
Email: mchangchun@pbc.gov.cn, digang@pbc.dci.cn

Xiaoyun Wang
Tsinghua University
Email: xiaoyunwang@tsinghua.edu.cn

Abstract—State-of-the-art Byzantine fault-tolerant (BFT) protocols assuming partial synchrony such as SBFT and HotStuff use *regular certificates* obtained from $2f + 1$ (partial) signatures. We show in this paper that one can use *weak certificates* obtained from only $f + 1$ signatures to assist in designing more robust and more efficient BFT protocols. We design and implement two BFT systems: Dashing (a family of two HotStuff-style BFT protocols) and Star (a parallel BFT framework).

We first present Dashing1 that targets both efficiency and robustness using weak certificates. Dashing1 is also network-adaptive in the sense that it can leverage network connection discrepancy to improve performance. We demonstrate that Dashing1 outperforms HotStuff in various failure-free and failures scenarios. We further show in Dashing2 how to further enable a *one-phase* fast path by using *strong certificates* obtained from $3f + 1$ signatures, a highly challenging task we tackled in the paper.

We then leverage weak certificates to build Star, a highly efficient BFT framework that delivers transactions from $n - f$ replicas using only a single consensus instance. Star compares favorably with existing protocols in terms of censorship resistance, communication complexity, pipelining, state transfer, performance and scalability, and/or robustness under failures.

We demonstrate that the Dashing protocols achieve 47%-107% higher peak throughput than HotStuff for experiments conducted on Amazon EC2. Meanwhile, unlike all known BFT protocols whose performance degrades as f grows large, the peak throughput of Star keeps increasing as f grows. When deployed in a WAN with 91 replicas across five continents, Star achieves an impressive throughput of 256 ktx/sec, 35.9x that of HotStuff, 23.9x that of Dashing1, and 2.38x that of Narwhal.

1. Introduction

Byzantine fault-tolerant state machine replication (BFT) is known as the core building block for permissioned blockchains. This paper focuses on highly efficient, partially

synchronous BFT protocols [10], [15]. Almost universally, these protocols rely critically on *regular (quorum) certificates* which, roughly speaking, are sets with at least $2f + 1$ messages from different replicas. Recent protocols such as SBFT [21] and HotStuff [40] require using (threshold) signatures for regular certificates as transferable proofs.

This paper demonstrates that one can build BFT systems that outperform existing ones—in one way or another—by using *weak certificates* with at least $f + 1$ signatures from different replicas.

Intuitively, weak certificates may lead to more efficient BFT protocols, because replicas only need to wait for signatures from $f + 1$ replicas and combine only $f + 1$ signature shares. Indeed, as shown in prior works (e.g., [14]), Byzantine agreement protocols with the $f + 1$ threshold can be (much) more efficient than their counterparts with the $2f + 1$ threshold. *This paper explores novel usages of weak certificates much beyond this intuition.*

Table 1 summarizes our protocols using weak certificates. The Dashing protocols (Dashing1 and Dashing2) are new BFT protocols in the HotStuff family and gain in efficiency during failure-free cases and robustness under unexpected network interruptions. Star is a new asynchronous BFT framework targeting scalability.

1.1. Dashing: Gaining in Efficiency, Network Adaptivity, and Robustness

In Dashing, we challenge the conventional wisdom and offer new insights into the design of BFT protocols.

- **Using weak certificates.** It is well-known that BFT protocols need to use regular certificates to ensure liveness and safety. So far, weak certificates are shown not to be helpful in building faster BFT protocols. Our first goal is to challenge the intuition and provide a *meaningful* way of using weak certificates to assist in the BFT design.
- **Leveraging network connection discrepancy.** When designing and evaluating a partially synchronous BFT protocol, we implicitly assume the simplistic network configuration, where replicas communicate with each

*. Corresponding author.

protocols	section	QC type used	features	authenticator	communication
Dashing1	Sec. 3.4	wQC; rQC	network-adaptive; more robust and efficient	$O(n)$	$O(Ln + \lambda n)$
Dashing2	Sec. 3.5	wQC; rQC; sQC	targeting low latency; one-phase fast path	$O(n)/O(n^2)$	$O(Ln + \lambda n^2)$
Star	Sec. 4	wQC; rQC	1. pipelined transmission; 2. weak certificates for efficiency; 3. effective blockchain quality; 4. efficient state transfer; 5. lower communication	$O(n^2)$	$O(Ln^2 + \lambda n^2)$

TABLE 1: Our protocols. L is the proposal size for each replica and λ is the security parameter. As Star allows replicas to process $n - f$ transactions in parallel, one cannot simply say that the Dashing protocols have lower communication complexity than Star.

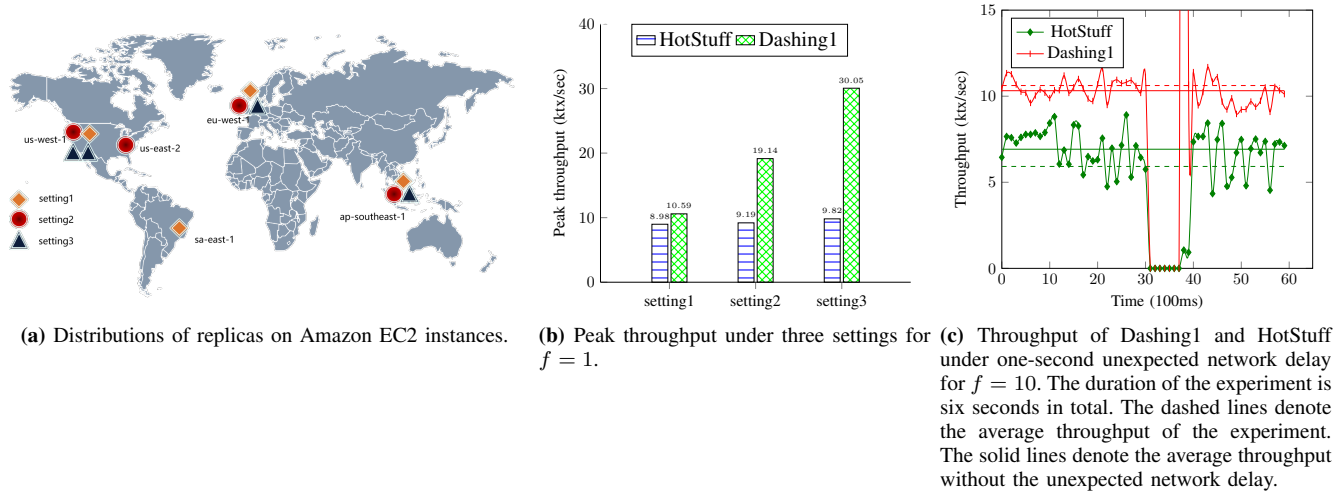

Figure 1: Throughput of HotStuff and Dashing1 in three different settings on Amazon EC2.

other with about the same latency (either all in LANs or WANs). But in practice, the latency discrepancy among different replicas naturally exists. A realistic scenario is that some replicas (say, 1/3 of the replicas) naturally have better connections than the rest of them. We find the fact is overlooked by existing BFT protocols. We experimentally show in Fig. 1 that HotStuff does not exhibit visible performance differences even if we place some replicas in the same region. The result is somewhat expected: intuitively, the safety of BFT depends on the BFT network overall, so the performance of BFT should depend on the BFT network overall. Again, we challenge this intuition, showing that BFT can benefit from network connection discrepancies.

- **Useful work during asynchrony.** Partially synchronous BFT protocols cannot make progress during asynchrony. Existing partially synchronous BFT protocols would simply wait until the network becomes synchronous (before view change occurs) or loop on view changes—in either case, no "meaningful" progress can be made. The situation is only exacerbated, if the network is intermittently synchronous or adaptively manipulated [32]. Naturally, it seems that there is nothing we can do about the situation: existing partially synchronous BFT protocols are deterministic and subject to the celebrated FLP impossibility result [16]. We take a fresh look at the problem: while one indeed cannot make progress during asynchrony, we do not waste our computation and network bandwidth during asynchrony. The idea is that we perform "useful" operations such that once the network becomes synchronous, we can efficiently commit a large number of

cumulative transactions—the longer the asynchrony, the more transactions committed—in some sense, the "best" that one could anticipate.

Dashing1. One crucial idea in Dashing1 is that we attempt to use weak certificates instead of regular certificates *as much as possible*—during the normal case, during transient failures or network interruptions, during unresponsive replicas (e.g., crashes, slow replicas), and during view changes. Transforming the idea into a fully secure BFT protocol, however, is tricky: we have tackled subtle safety and liveness challenges within a view and across views due to the usage of weak certificates. Correspondingly, Dashing1 gains in improved efficiency and robustness in various scenarios, including during normal cases and across views, and in the presence of transient network interruptions, network connection discrepancies, and unresponsive failures.

As shown in Fig. 1a, we deploy HotStuff and Dashing1 on Amazon EC2 (for $f = 1$ and $n = 4$) in three different settings: in setting 1, the four replicas are distributed in four continents; in setting 2 and setting 3, we place two of the replicas in closer locations. In all three settings (Fig. 1b), we find Dashing1 consistently outperforms HotStuff; in setting 1 and setting 2, Dashing1 achieves about 2x and 3x the throughput of HotStuff, respectively. The experiments show that Dashing1 achieves improved performance in the normal case and in the presence of (natural) network connection discrepancies.

As another example (Fig. 1c), we run an experiment for Dashing1 and HotStuff with 1,200 clients for a duration of six seconds in a WAN setting with 31 replicas. In the middle of the experiments, we inject a one-second network

delay using the *qdisc* traffic control command. While neither HotStuff nor Dashing1 can make progress during the network delay, the throughput of Dashing1 reaches roughly 10x that of HotStuff when the network recovers. The average throughput of Dashing1 is 79.3% and 49.1% higher than that of HotStuff with the unexpected network delay (dashed line) and without the delay (solid line), respectively. Moreover, Dashing1 achieves roughly the same average throughput as that without the delay, while we witness a more visible decrease in throughput for HotStuff.

We also show in the paper that Dashing1 enjoys better robustness and efficiency in various other scenarios such as leader failures and backup failures.

Dashing2. We show how to enable a one-phase fast path by leveraging *strong certificates* from $3f + 1$ signatures in our BFT protocols. We demonstrate that such a task is technically challenging—being more subtle than that in SBFT [21]—and offer a secure and efficient solution.

1.2. Star: Gaining in Efficiency and Scalability

We use weak certificates to help build Star, a highly scalable BFT framework that delivers transactions from $n - f$ replicas using only a single consensus instance. As depicted in Fig. 2, Star completely separates bulk data transmission from consensus such that these two processes can be run independently, an idea originally from [13]. Star has five distinctive features compared to prior works: 1) the data transmission process can be effectively *pipelined* to gain in efficiency; 2) Star uses weak certificates for the data transmission process to further improve performance; 3) unlike prior works, the transmission process and the consensus process are implicitly "correlated" with epoch numbers, and the consensus process only handles messages transmitted in the same epoch, which helps achieve effective censorship resilience and *blockchain quality* (at least 1/2 of the total transactions contained in a committed block in an epoch are from correct replicas); 4) Star admits a more efficient ($O(1)$ time) state transfer mechanism outpacing existing ones; and 5) Star achieves lower communication complexity than existing protocols.

All the features add up to a highly scalable and robust BFT framework. Simply using PBFT [11] in our underlying consensus layer, Star is the first conventional BFT protocol whose throughput strictly keeps increasing as n grows. As illustrated in Fig. 3, when deploying Star, HotStuff, Narwhal [13] (the state-of-the-art protocol¹) in a WAN with 91 replicas across five continents, Star achieves a throughput of 256 ktx/sec, 35.9x that of HotStuff and 2.38x that of Narwhal.

Comparison with existing protocols. Besides the performance and scalability benefits, Star compares favorably with existing protocols, such as Narwhal [13], Bullshark [20], ISS [37], Mir-BFT [36], and Dumbo-NG [17], in terms of

1. As claimed by authors in Bullshark [20], Bullshark and Narwhal share almost identical throughput in normal cases (as they share the same mempool protocol), and BullShark offers almost 2x the throughput of MirBFT at the same latency.

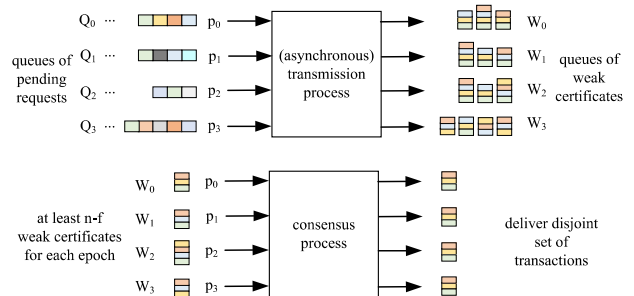

Figure 2: The Star BFT framework. Star consists of an asynchronous transmission process (that takes as input queues of pending transactions and outputs queues of weak certificates) and a consensus process (that takes at input $n - f$ weak certificates and outputs a union of transactions corresponding to the weak certificates delivered). Two processes are run independently but are implicitly correlated with an increasing epoch number.

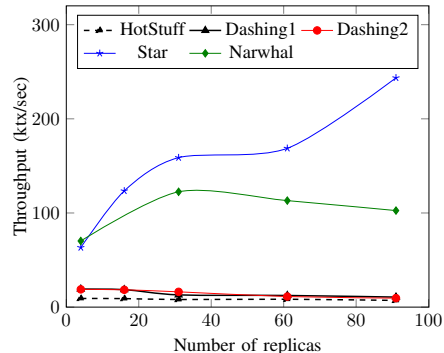

Figure 3: Throughput of the protocols in WAN (with default setting1 on AWS EC2) as f grows.

censorship resistance, message complexity, pipelined transmission, state transfer, and/or performance under failures.

Concurrent to our work (posted online May 2022), Gao, Lu, Lu, Tang, Xu, and Zhang proposed Dumbo-NG [17] (posted online Sep 2022), an asynchronous BFT protocol. Indeed, while we instantiate Star using a partially synchronous BFT protocol, Star can be an asynchronous BFT protocol if the underlying BFT is asynchronous. Moreover, both Dumbo-NG and Star separate message transmission from agreement. However, Star does not use any of the other three techniques we used to improve efficiency or blockchain quality: 1) weak certificates for better efficiency; 2) associating transmission layer and consensus layer with epoch numbers for better blockchain quality; 3) a more efficient state transfer mechanism. In particular, without associating transmission layer with consensus layer, a specific transaction could be significantly delayed or censored due to faster commitments of transactions initiated by faulty replicas. Indeed, faulty replicas can form a long chain consisting of an unbounded number of certificates. In this way, a specific transaction may have the opportunity to be processed only after all associated transactions from faulty replicas have been committed, losing constant commit time; moreover, the fraction of transactions from correct replicas

in a block may be made arbitrarily small.

Different from ISS [37] (and its predecessor MirBFT [36]) that require running n parallel consensus protocols for each epoch, Star only needs to run a single consensus protocol for each epoch. ISS relies on Byzantine failure detector to ensure safety and liveness, and replicas have to wait for the slowest consensus instance to terminate (possibly with view changes or until timers run out) before they can process transactions; in contrast, Star can process transactions once the single consensus instance completes. Also, Star achieves $O(n^2)$ messages, which is in contrast to ISS that incurs at least $O(n^3)$ messages. Last, during crash failures, the throughput of ISS and MirBFT may drop to 0 for a long period of time; it needs to run a reconfiguration mechanism to exclude faulty replicas [36], [37].

1.3. Summary of Contributions

We summarize our contributions in the following.

- We design a family of Dashing protocols—Dashing1 and Dashing2—using weak certificates. In particular, Dashing1 gains in improved efficiency and robustness in both failure and failure-free scenarios and in normal cases and across views; unlike prior partially synchronous protocols, Dashing1 excels in performance in the presence of transient network interruptions and network connection discrepancies. Dashing2 enables a one-phase fast path for Dashing1 and offers improved latency.
- We provide a novel (asynchronous) BFT framework (Star) allowing one to process transactions in parallel using only one BFT instance and $O(n^2)$ messages. Star separates a pipelined message transmission layer from the consensus layer, yet associates the layers using an increasing epoch number. Doing so allows us to achieve a strong blockchain quality property. Additionally, Star enables an $O(1)$ time state transfer (recovery) mechanism that is much more efficient than existing ones.
- We formally prove the correctness of all our protocols.
- We implement the BFT protocols (the two Dashing protocols and an instantiation of Star). We have performed extensive evaluations of the protocols, showing that our protocols outperform existing protocols in various metrics.

2. System Model

BFT. This paper studies Byzantine fault-tolerant state machine replication (BFT) protocols. In a BFT protocol, clients *submit* transactions (requests) and replicas *deliver* them. The client obtains a final response to the submitted transaction from the replica responses. In a BFT system with n replicas, it tolerates $f \leq \lfloor \frac{n-1}{3} \rfloor$ Byzantine failures. The correctness of a BFT protocol is specified as follows:

- **Safety:** If a correct replica *delivers* a transaction tx before *delivering* tx' , then no correct replica *delivers* a transaction tx' without first *delivering* tx .

- **Liveness:** If a transaction tx is *submitted* to all correct replicas, then all correct replicas eventually *deliver* tx .

Liveness is alternatively called "censorship resilience" (a blockchain terminology). We use them interchangeably.

We also need an equivalent primitive, atomic broadcast, as a building block. Atomic broadcast is only syntactically different from BFT. In atomic broadcast, a replica *a-broadcasts* messages and all replicas *a-deliver* messages.

- **Safety:** If a correct replica *a-delivers* a message m before *a-delivering* m' , then no correct replica *a-delivers* a message m' without first *a-delivering* m .
- **Liveness:** If a correct replica *a-broadcasts* a message m , then all correct replicas eventually *a-deliver* m .

Note that when describing atomic broadcast, we restrict the API of atomic broadcast in the sense that only a single replica *a-broadcasts* a message. One can alternatively allow all replicas to *a-broadcast* transactions (which is the case for completely asynchronous protocols).

This paper mainly considers the partially synchronous model [15], where there exists an unknown global stabilization time (GST) such that after GST, messages sent between two correct replicas arrive within a fixed delay. One of our protocols (Star) works in completely asynchronous environments if the underlying atomic broadcast protocol is asynchronous.

(Best-effort) broadcast. We use the term "broadcast" to represent that event that a replica sends a message to all replicas in a system.

Cryptographic building blocks. We define a (t, n) threshold signature scheme with the following algorithms ($tgen$, $tsign$, $tcombine$, $tverify$). $tgen$ outputs a threshold signature public key and a vector of n private keys. A signature signing algorithm $tsign$ takes as input a message m and a private key sk_i and outputs a partial signature σ_i . A combining algorithm $tcombine$ takes as input pk , a message m , and a set of t valid partial signatures, and outputs a signature σ . A signature verification algorithm $tverify$ takes as input pk , a message m , and a signature σ , and outputs a single bit. We require the robustness and unforgeability properties for threshold signatures. When describing the algorithms, we leave the verification of partial signatures and threshold signatures implicit.

Dedicated threshold signatures can be realized using pairings [7], [8]. One can also use a group of n signatures to build a (t, n) threshold signature for efficiency, as used in various libraries such as HotStuff [40], [1], Jolteon and Ditto [18], and Wendy [19]. The approach is also preferred for our protocols, as many of our protocols have more than one thresholds. (Otherwise, one should use different threshold signatures for different thresholds.)

We use a collision-resistant hash function *hash* mapping a message of arbitrary length to a fixed-length output.

Byzantine quorums and quorum certificates. We assume $n \geq 3f + 1$ for our protocols. For simplicity, we simply let $n = 3f + 1$ for this paper. A Byzantine quorum consists of $\lceil \frac{n+f+1}{2} \rceil$ replicas, or simply $2f + 1$ if $n = 3f + 1$. We call it a *regular quorum*.

Slightly abusing notation, we additionally define two different types of quorums: a *weak quorum* consisting of $f + 1$ replicas and a *strong quorum* consisting of $n = 3f + 1$ replicas. A message with signatures signed by a weak quorum, a regular quorum, and a strong quorum is called a *weak (quorum) certificate* (wQC), a *regular (quorum) certificate* (rQC), and a *strong (quorum) certificate* (sQC), respectively. A certificate can be a threshold signature with a threshold t or a set of t digital signatures.

3. The Family of Dashing Protocols

3.1. Overview of (Chained) HotStuff

HotStuff describes the syntax of leader-based BFT replication using the language of trees over blocks for leader-based protocols. Here we use a slightly more general notation, where multiple blocks, rather than just one block, may be delivered within a view until view change occurs.

Each replica stores a tree of blocks. A block b contains a parent link pl , a batch of transactions, and their metadata. A parent link for b is a hash of its parent block. A branch led by a given block b is the path from b all the way to the root of the tree (i.e., the *genesis* block). The *height* for b is the number of blocks on the branch led by b .

Each time, a monotonically growing branch becomes committed and a block extends the branch led by its parent block. A block b' is an extension of a block b , if b is on the branch led by b' . Two branches are conflicting, if neither is an extension of the other. Two blocks are conflicting, if the branches led by the blocks are conflicting. A safe BFT protocol must ensure that no two correct replicas commit two conflicting blocks.

HotStuff uses three phases (*prepare phase*, *precommit phase*, and *commit phase*) to deliver a block. In the prepare phase, the leader broadcasts a proposal (a block) b to all replicas and waits for signed responses (also called votes) from a quorum of $n - f$ replicas to form a threshold signature as a quorum certificate (*prepareQC*). In the following precommit phase, the leader broadcasts *prepareQC* and waits for responses to form *precommitQC*. Similarly, in the commit phase, the leader broadcasts *precommitQC*, and waits to form and broadcasts *commitQC*. Upon receiving the *precommitQC*, a replica becomes *locked* on b . Upon receiving the *commitQC*, a replica delivers b .

In case of view changes, each replica sends its latest *prepareQC* to the leader. Upon receiving a quorum of $n - f$ such messages, the leader selects the QC with the largest height and extends the block for the QC using a new proposal.

Throughout the paper, we use the chained version for HotStuff and the Dashing protocols, where phases are overlapped and pipelined.

3.2. Overview of Dashing1

Dashing1 in a nutshell. In Dashing1, we use weak certificates (signatures from $f + 1$ replicas) to improve on both

efficiency and robustness. The core idea is that we attempt to use weak certificates *as much as possible*, during normal cases and across views, and in the presence of transient network interruptions and network connection discrepancies. In any of above cases, we allow replicas to "proceed" with weak certificates.

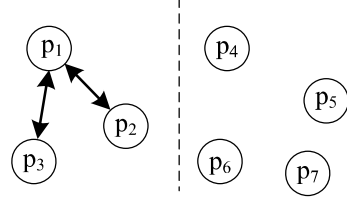

Figure 4: Dashing1 under unexpected network delay.

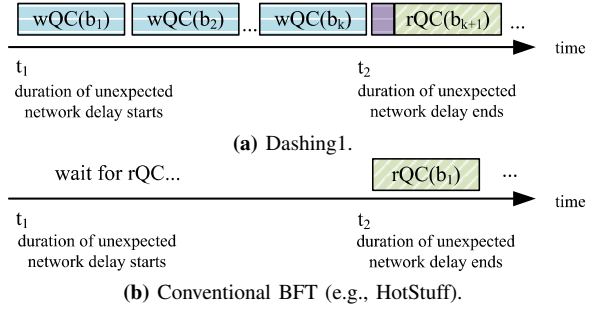

Figure 5: The way how Dashing1 and a regular BFT handle unexpected network delays, respectively.

As an example, Fig. 4 describes a scenario with unexpected network delay, where the leader p_1 can only receive messages from two other replicas (p_2 and p_3). As long as the network interruption persists, replicas in existing BFT protocols cannot make meaningful progress. For partially synchronous BFT protocols, the leader has to wait until a regular certificate is formed, or until view change occurs. In contrast, Dashing1 allows replicas to make meaningful progress and accumulate proposals under unexpected delays.

Fig. 5a describes the way how Dashing1 and a regular BFT protocol (e.g., HotStuff) handle unexpected network delays. For both protocols, starting from time t_1 , the leader could not form a rQC until t_2 when the network resumes synchronous. During the network delay, the leader in the regular BFT protocol proposes block b_1 and waits for its rQC.

In contrast, for the case of Dashing1, the leader can form a sequence of wQCs for blocks b_1, \dots, b_k . Then when the network becomes synchronous, replicas that fail to receive messages from the leader will catch up with the leader. This catching up phase, as we find, completes in a very short period of time, in contrast to the process of proposing blocks and collecting wQCs. Then replicas resume their normal-case operation and rQCs can be formed. After three rQCs for block b_{k+1} are formed, blocks b_1, \dots, b_{k+1} are committed simultaneously. Namely, during expected network delays or interruptions, we do not waste our computation and network bandwidth; once the network becomes synchronous, we can commit all the cumulative transactions simultaneously and instantaneously.

Note that if $t_2 - t_1$ is larger than the view change timer, view change will be triggered. Even during a view change, the design of Dashing1 allows the new leader (if correct) to create a new proposal based on wQCs from the prior view. With the new leader, once a single transaction with rQC is committed, all prior wQCs can be simultaneously delivered. Namely, the view change protocol in Dashing1 can also benefit from our design.

With our design, Dashing1 can naturally leverage network connection discrepancy for adaptive performance. The performance of Dashing1 depends on the group of fast replicas (1/3 of total replicas) rather than the Byzantine quorum of replicas (the overall network condition). Meanwhile, we can carefully setup timers such that our system can also benefit from wQCs even in the normal case.

Challenges and our design. Transforming the idea into a fully secure BFT protocol, however, is non-trivial. First, a faulty leader may easily create forks and generate up to $2f + 1$ conflicting weak certificates. To prevent the forks from growing exponentially, we can ask each correct replica to vote for at most one block at each height.

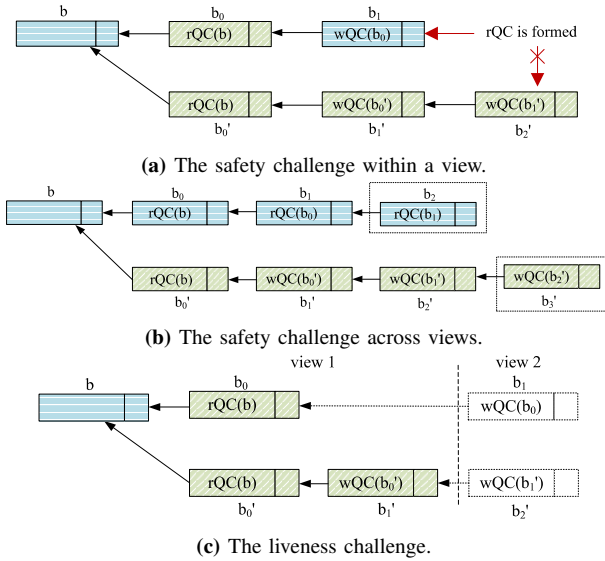

Figure 6: Challenges of building BFT from weak certificates. Blue boxes with horizontal lines and green boxes with diagonal lines represent blocks such that regular certificates and weak certificates are formed, respectively. (The figures are best viewed in color.)

Second, we need to ensure that safety is still preserved in the presence of weak certificates. Namely, we should guarantee that if two conflicting blocks are extended from two conflicting branches, a regular certificate can only be formed for at most one of them. As shown in Fig. 6a, b_0 and b'_0 are conflicting blocks and weak certificates are formed for both of them. In addition, b_1 extends b_0 and b'_1 extends b'_0 . Then a regular certificate is formed for b_1 . While a weak certificate can still be formed for b'_1 and its descendant blocks, we need to ensure that a regular certificate will never be formed for any of them. We solve the problem by enforcing a constraint: if a replica receives a proposal for a block (e.g., b'_2) that extends a block with a weak certificate

(i.e., b'_1), a replica votes for block b'_2 if and only if it has previously voted for the parent block b'_1 . In this example, as $2f + 1$ replicas have already voted for b_1 , it is impossible that $2f + 1$ replicas will vote for b'_2 .

Third, we need to ensure that across view changes (or in the rotating leader mode), transactions with weak certificates can be processed. During view changes, we ask each replica to send its *highest* weak certificate to the new leader and the new leader can select a weak certificate to create a new proposal. After the proposed block is committed, all the blocks on the branch led by the block will be committed. However, we cannot simply let the new leader select the highest wQC it receives due to a subtle safety problem. As shown in Fig. 6b, rQCs are formed for b_0, b_1 , and b_2 , while wQCs for b'_0, b'_1, b'_2 , and b'_3 are formed too (a "fork"). Note that a rQC for b_2 is also the *commitQC* for b_0 . If a view change occurs and we let the leader select the highest weak certificate b'_3 , a proposal extending b'_3 will be proposed. To attain liveness, all replicas need to vote for the proposal and b'_3 will be committed. But b_0 has already been committed by at least one correct replica, violating safety. To address this issue, for any block b , we define *stable block* as the highest block for which a rQC has been formed on the branch led by b . Correspondingly, we require that each block b additionally maintains a *stable link* field sl which stores the hash digest of the stable block of b . (Note that the use of the stable link resembles the use of the parent link.) After the leader collects the certificates from the replicas, it will either select the highest rQC, or the wQC for which the stable block is the highest. In this example, as the stable block of b'_3 is b and b is lower than b_2 , the leader will create a proposal extending b_2 . Upon receiving a proposal b' , if b' extends a rQC for b , replicas decide whether to vote for b' by comparing b 's stable block to its locked block (just as in HotStuff).

In fact, allowing the new leader to extend a weak certificate during view changes introduces a liveness challenge. Recall that in the normal case operation, we ask every replica to vote a block b that extends a weak certificate only if the replica has voted for the parent block of b . Unfortunately, we cannot enforce the same rule during view changes, as there may not even exist $f + 1$ correct replicas that have previously voted for the parent block of b . Fig. 6c illustrates an example where in view 1, the leader creates forks by creating multiple weak certificates, and in view 2, the new leader receives a weak certificate for b_0 or b'_1 (or both). According to the rule (for the normal case), the leader is allowed to extend a weak certificate and create a proposal (e.g., b_1 that extends b_0 or b'_2 that extends b'_1). As b_0 and b'_1 have been voted by only $f + 1$ replicas, there is no guarantee that either b_1 or b'_2 will be voted by $f + 1$ correct replicas in view 1. In this scenario, a proposal from a correct replica will not be voted by any correct replica, creating a liveness issue. To address this challenge, we require that a correct replica p_i decide whether to vote for a block extending a wQC (e.g., b_1) during view change by comparing the stable block of received block to the locked block of p_i . In the example, p_i vote for b_1 if p_i is not locked on a conflicting block of b (the stable block of b_1).

One more (liveness) challenge is about timers. In Dashing1, besides the regular view change timer Δ_1 , the leader additionally maintains a timer Δ_2 . After forming a wQC with $f + 1$ matching votes, the leader starts a timer Δ_2 . The leader can propose a new block if either of the two conditions is met: 1) Δ_2 expires (and it has not formed a rQC); 2) it forms a rQC. We need to be careful about Δ_2 . According to our experiments, even if Δ_2 is set as a relatively small value (or even 0), the percentage of rQCs formed among all QCs, perhaps surprisingly, is large. This is because while a replica is packing the proposal, more signatures may have been received and a rQC can be formed. Note, however, a too small Δ_2 may lead to lower number of rQCs formed and increased latency. Also note that while a too small Δ_2 may trigger view change, but the view change in Dashing1 is as efficient as that in HotStuff. To deal with the situation, we require that after a view change, the new leader needs to form three consecutive rQCs; doing so allows all corresponding blocks for wQCs accumulated in the prior view can be committed. In addition, we *optionally* limit the number of consecutive wQCs for the normal case to avoid unnecessary view changes. Namely, we can add an additional rule such that a leader needs to form three consecutive rQCs once every k (a constant, say, 50) wQCs have been extended on the branch. Namely, we enforce the leader to commit at least one block with rQC after proposing "sufficient" blocks with wQCs. Doing so ensures that even with too small Δ_2 values, view change might not be triggered.

Note that an overly large Δ_2 does not cause any (performance) issues, as the leader will propose a new block once $n - f$ votes are received. Namely, even if we set an overly large Δ_2 , Dashing1 would remain as least as efficient as HotStuff and Dashing1 remains optimistically responsive. Also we comment that in settings where there exists natural network discrepancies, we set Δ_2 according to concrete network connection conditions.

The last challenge is to maintain certificates with two thresholds. If favoring maintaining linear authenticator complexity using threshold signatures, one should setup two threshold signature schemes—one for wQCs and the other for rQCs. In each round-trip communication, replicas should generate both a partial signature for wQC and a partial signature for rQC. The leader should maintain two sets storing threshold signatures for wQC and rQC, respectively. In a different approach, one can simply use conventional signatures and track all valid signatures in a single set. In our implementation, we adopt the second approach that uses conventional signatures, one also used in a series of HotStuff libraries [40], [34], [19], [1].

3.3. Notation for Dashing Protocols

We specify the notation for the Dashing protocols.

Blocks. A block b is of the form $\langle req, pl, sl, view, height \rangle$. We use $b.x$ to represent the element x in block b . Fixing a block b , $b.pl$ is the hash digest of b 's parent block, $b.height$ is the number of blocks on the branch led by b , and $b.view$

is the view in which b is proposed. Note that different from prior notation, sl is a new element in b . Formally, $b.sl$ denotes the hash digest of b 's stable block (the highest block with a regular certificate on the branch led by b). For simplicity, we also use $b.parent$ and $b.stable$ to represent the parent block and the stable block of b , respectively.

Messages. Messages transmitted among nodes are of the form $\langle TYPE, block, justify \rangle$. We use three message types: GENERIC, VIEW-CHANGE, and NEW-VIEW. The VIEW-CHANGE and NEW-VIEW messages are used during view change: VIEW-CHANGE messages are sent by replicas to the next leader, while NEW-VIEW message is sent by the new leader to the replicas. The *justify* field stores certificates to validate the *block*. Fields may be set as \perp .

Functions and notation for QCs. A QC for message m is also called a QC for $m.block$. Fixing a QC qc for a block b , let $QCBlock(qc)$ return the block b .

We have discussed two approaches to maintaining wQCs and rQCs (the last paragraph in Sec. 3.2). To hide the implementation detail, we let $QCVote(m)$ denote the output of a partial signature signing algorithm for m or a conventional signing algorithm and let $QCCreate(M)$ be a QC generated from signatures in M . $QCCreate(M)$ may be a wQC or a rQC.

Rank of QCs and blocks. Following the notion in [18], we now define the *rank()* function for QCs and blocks. *rank()* does not return a concrete number. Instead, it takes as input two blocks/QCs and outputs whether the rank of a block/QC is higher than the other one. The rank of two blocks/QCs is first compared by the view number, then by the height.

Local state at replicas. Each replica maintains the following state parameters, including the current view number *cview*, the highest rQC QC_r , the highest wQC QC_w , the locked block lb , and the last voted block vb .

3.4. Dashing1

We present in Algorithm 2 and Algorithm 3 the normal case protocol and view change protocol of Dashing1, respectively. The utility functions are presented in Algorithm 1. We largely follow the description of HotStuff and highlight how Dashing1 supports wQCs in dotted boxes.

Normal case protocol (Algorithm 2). We describe the chained version of the protocol. In each phase, the leader broadcasts a message to all replicas and waits for signed responses from replicas. At Ln 10, the leader first proposes a new block b and broadcasts a $\langle GENERIC, b, qc_{high} \rangle$ message, where qc_{high} is the last QC it receives (either a wQC or a rQC). The leader waits for the votes from the replicas. After collecting $f + 1$ matching votes, the leader starts a timer Δ_2 (Ln 6) to determine whether the leader should stop waiting for more votes and propose a new block. Namely, the leader can propose a new block if either one of the two conditions is met: 1) Δ_2 expires; 2) it forms a rQC. After that, the leader combines the signatures in the votes into qc_{high} for the next phase.

Upon receiving a $\langle GENERIC, b, \pi \rangle$ message from the leader, each replica p_i first verifies whether b is well-formed

Algorithm 1: Utilities

```

1 procedure CREATEBLOCK( $b', v, req, qc$ )
2    $b.pl \leftarrow hash(b')$ ,  $b.parent \leftarrow b'$ ,  $b.height \leftarrow b'.height + 1$ 
3    $b.req \leftarrow req$ ,  $b.view = v$ 
4   if  $qc$  is a wQC then
5      $b.sl \leftarrow b'.sl$ ,  $b.stable \leftarrow b'.stable$ , return  $b$ 
6   if  $qc$  is a rQC then  $b.sl \leftarrow b.pl$ ,  $b.stable \leftarrow b'$  return  $b$ 
7 procedure STATEUPDATE( $QC_w, QC_r, lb, qc$ )
8    $b' \leftarrow QCBLOCK(qc)$ ,  $b'' \leftarrow b'.parent$ ,  $b^* \leftarrow b''.parent$ ,
9    $v \leftarrow b'.view$ ,  $b_0 \leftarrow QCBLOCK(QC_w)$ ,  $b_{high} \leftarrow QCBLOCK(QC_r)$ 
10  if  $qc$  is a rQC then
11    if  $rank(b') > rank(b_{high})$  then  $QC_r \leftarrow qc$ 
12    if  $b'.stable = b''$  and  $rank(b'') > rank(lb)$  then  $lb \leftarrow b''$ 
13    if  $b'.stable = b''$  and  $b''.stable = b^*$  and
14     $b'.view = b^*.view = v$  then
15    deliver the transactions in  $b^*$  and ancestors of  $b^*$ 
16  if  $qc$  is a wQC and  $rank(b'.stable) \geq rank(b_0.stable)$  then
17     $QC_w \leftarrow qc$ 

```

Algorithm 2: Normal case protocol for Dashing1

```

1 initialization:  $cview \leftarrow -1$ ,  $vb$ ,  $QC_w$ ,  $QC_r$ ,  $lb$  are initialized to  $\perp$ 
2 Start a timer  $\Delta_1$  for the first request in the queue of pending
  transactions
3 > GENERIC phase:
4 as a leader
5 wait for votes for  $b$ :
6    $M \leftarrow \{\sigma | \sigma \text{ is a signature for } \langle \text{GENERIC}, b, \perp \rangle\}$ 
7 upon  $|M| = f + 1$  then set a start timer  $\Delta_2$ 
8 upon  $\Delta_2$  timeout or receiving  $n - f$  matching messages then
9    $qc_{high} \leftarrow QCCREATE(M)$ 
10   $b \leftarrow CREATEBLOCK(b, cview, req, qc_{high})$ 
11  broadcast  $m = \langle \text{GENERIC}, b, qc_{high} \rangle$ 
12 as a replica
13 wait for  $m = \langle \text{GENERIC}, b, \pi \rangle$  from LEADER( $cview$ )
14    $b' \leftarrow b.parent$ ,  $b'' \leftarrow b'.parent$ ,  $b_s \leftarrow b.stable$ 
15    $m \leftarrow \langle \text{GENERIC}, b, \perp \rangle$ 
16   if  $rank(b') \geq rank(b)$  or  $b.height \neq b'.height + 1$ 
17     discard the message
18   if  $\pi$  is a wQC for  $b'$  and  $b_s = b'.stable$  and
19      $b_s.view = b'.view = b''.view = cview$  and  $b' = vb$  then
20      $vb \leftarrow b$ , STATEUPDATE( $QC_w, QC_r, lb, \pi$ )
21   if  $\pi$  is a rQC for  $b'$  and  $b_s = b'$  and  $rank(b') \geq rank(vb)$ 
22      $vb \leftarrow b$ , STATEUPDATE( $QC_w, QC_r, lb, \pi$ )
23   if  $vb = b$  then send QCVOTE( $m$ ) to LEADER( $cview$ )
24 > NEW-VIEW phase: switch to this line if  $\Delta_1$  timeout occurs
25 as a replica
26    $cview \leftarrow cview + 1$ 
27   send  $\langle \text{VIEW-CHANGE}, \perp, (QC_r, QC_w) \rangle$  to LEADER( $cview$ )

```

(In 13-16), i.e., b has a higher rank than its parent block b' and $b.height = b'.height + 1$. Let b'' denote the parent of b' , we distinguish two cases. For ease of understanding, we illustrate in Fig. 7 the relationships of b , b' , b'' , and b^* .

- If the π field is a wQC for b' (In 17), p_i verifies if the stable block of b and b' are the same block such that b indeed extends b' . p_i also verifies if b , b' and b'' are all proposed in the same view and p_i has previously voted for b' . If so, p_i updates its local parameter QC_w to π and creates a signature for b (Algorithm 1, In 15).
- If π is a rQC for b' (In 18-19), p_i verifies if b' 's parent block b'' has a higher rank than vb . If so, p_i updates its

Algorithm 3: View change protocol for Dashing1

```

1 > VIEW-CHANGE phase
2 as a new leader
3  $M$  is a set of  $n - f$  VIEW-CHANGE messages collected by
  the new leader
4  $qc_{high} \leftarrow$  the rQC with the highest rank contained in  $M$ 
5  $b_1 \leftarrow QCBLOCK(qc_{high})$ 
6 for  $m \in M$ 
7   if a wQC  $qc_d \in m.justify$  and  $QCBLOCK(qc_d) = d$  and
8      $rank(d.stable) > rank(b_0.stable)$  then  $vc \leftarrow qc_d$ ,  $b_0 \leftarrow d$ 
9   if  $rank(b_0.stable) \geq rank(b_1)$  then
10     $b \leftarrow CREATEBLOCK(b_0, cview, req, vc)$ ,
11    broadcast  $m = \langle \text{GENERIC}, b, vc \rangle$ 
12  else then
13     $b \leftarrow CREATEBLOCK(b_1, cview, req, qc_{high})$ 
14    broadcast  $m = \langle \text{GENERIC}, b, qc_{high} \rangle$ 
15 //switch to normal case protocol
16 as a replica
17 wait for  $m = \langle \text{GENERIC}, b, \pi \rangle$  from LEADER( $cview$ )
18    $b' \leftarrow b.parent$ ,  $b_s \leftarrow b.stable$ ,  $m \leftarrow \langle \text{GENERIC}, b, \perp \rangle$ 
19   if  $b'.view \geq cview$  or  $rank(b') \geq rank(b)$  or
20      $b.height \neq b'.height + 1$  then
21     discard the message
22   if  $\pi$  is a wQC for  $b'$  and  $b_s = b'.stable$  and  $rank(b_s) \geq$ 
23      $rank(lb)$  then  $vb \leftarrow b$ , STATEUPDATE( $QC_w, QC_r, lb, \pi$ )
24   if  $\pi$  is a rQC for  $b'$  and  $b_s = b'$  and  $rank(b_s) \geq rank(lb)$ 
25     then  $vb \leftarrow b$ , STATEUPDATE( $QC_w, QC_r, lb, \pi$ )
26   if  $vb = b$  then send QCVOTE( $m$ ) to LEADER( $cview$ )
27 //switch to normal case protocol. Three consecutive rQCs are
  required for the first block proposed during the view change.
28 > NEW-VIEW phase: switch to NEW-VIEW phase if  $\Delta_1$ 
  timeout occurs

```

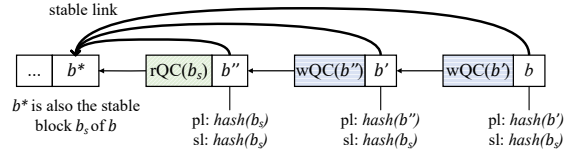

Figure 7: Illustration of the relationships of blocks in Algorithm 2.

local parameter QC_r to π and generates a signature. If b'' has a rQC and b'' has a higher rank than the locked block of p_i , then p_i updates its lb to b'' . If p_i has received a rQC for both b'' and b^* (the parent block of b''), then p_i commits block b^* and delivers transactions in b^* (Algorithm 1, In 6-14).

In both cases, the replica updates its vb to b , and sends its vote (a signature for m) to the leader (In 19).

View change protocol (Algorithm 3). Every replica starts timer Δ_1 for the first transaction in its queue. If the transaction is not processed before Δ_1 expires, the replica triggers view change. In particular, the replica sends a $\langle \text{VIEW-CHANGE}, \perp, (QC_r, QC_w) \rangle$ message to the leader (Algorithm 2, In 23). Upon receiving $n - f$ VIEW-CHANGE messages, the leader first obtains a block b_1 with a QC that has the highest rank (In 8). The leader then obtains a block b_0 with a wQC vc such that among all the blocks with weak QCs, b_0 has the highest stable block (first part of In 6). Then the leader checks if the rank of the stable block of b_0 is no less than that of b_1 (second part of In 6). If so, the leader creates a new block b extending b_0 and broadcasts b to all

replicas. Otherwise, the leader extends b_1 and creates block b and broadcasts to the replicas (ln 8 and ln 9).

Upon receiving a $\langle \text{GENERIC}, b, \pi \rangle$ message from a new leader, each replica p_i verifies if the proposed block b extends a block of a prior view (ln 14-15). Then p_i votes for b if either of the following conditions is satisfied:

- b extends a block b' with a wQC (ln 16), the stable blocks of b and b' are the same block (denoted as b_s), and the rank of b_s is no less than that of the locked block of p_i ;
- b extends a block b' with a rQC (ln 17-18), and the rank of the stable block of b is no less than that of the locked block of p_i .

For the first block proposed in a new view, the leader needs to collect three consecutive rQCs after replicas switch to normal case protocol (ln 20). As discussed in Sec. 3.2, this is crucial for dealing with the liveness challenge caused by the timer Δ_2 . Moreover, one may optionally enforce an additional rule such that the leader should commit at least one block after proposing "sufficient" blocks with wQCs (say, 100 wQCs).

State transfer. As in HotStuff, replicas in Dashing1 may need to perform state transfer with other replicas to obtain the QCs or transactions included in the QCs. For the state transfer of QCs, if a replica learns that a block b with height h is committed but it has not received any QCs between height h' of its locked block and h , the replica has to synchronize all the QCs for blocks between h' and h on the branch led by b . For the state transfer of the transactions, for each QC, the replica needs to obtain the proposal from other replicas such that the hash of the proposal matches that included in the QC.

We prove the correctness of Dashing1 in Appendix B.

3.5. Dashing2

We now show in Dashing2 how to further enable a fast path using strong certificates (sQCs). Intuitively, supporting $3f + 1$ threshold may allow replicas to deliver the transactions in a single phase: if the leader collects a sQC for a block and broadcasts to the replicas, replicas can directly commit the block.

While prior works have demonstrated how to design secure BFT protocols using strong quorums [2], [3], [21], integrating sQCs in Dashing1, however, has its unique challenges due to usage of wQCs. Indeed, as a block supported by a sQC may be extended from a block with only a weak certificate, replicas cannot directly commit the block upon receiving a sQC. As depicted in Fig. 8, two conflicting blocks b and b' are proposed in the same view 1 with the same height. Moreover, a rQC is formed for b and a wQC is formed for b' . Besides, a wQC for block b'_0 that extends b'_1 is formed. Suppose now a view change occurs, the new leader in view 2 extends b'_1 and proposes b'_2 . In Dashing1, replicas can vote for b'_2 , so a sQC can be formed. Then we consider a scenario where another view change occurs and replicas enter view 3. As there is no guarantee on how many correct replicas have received the sQC for b'_2 , the new

leader in view 3 may choose to extend b_0 . And b_0 can be later committed in view 3, in which case safety is violated as b'_2 is committed in view 2. As view change may occur at any moment, replicas cannot directly commit a block when a sQC is received.

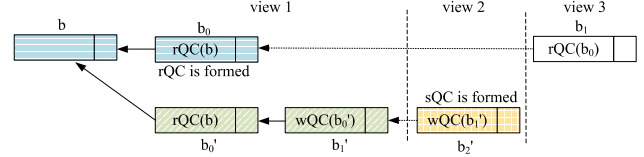

Figure 8: Challenge of integrating strong certificates in Dashing2.

In Dashing2, we treat a sQC for the first block proposed after view change as a rQC and the block cannot be committed immediately. Furthermore, during the view change, the new leader needs to send the VIEW-CHANGE messages from the replicas to all replicas, serving as a *proof* for the block it proposes. In fact, the view change protocol now becomes similar to that in Fast-HotStuff [24] and Jolteon [18]. Accordingly, Dashing2 has $O(n^2)$ authenticator complexity and $O(n)$ message complexity. In addition, Dashing2 is a two-phase protocol with a one-phase fast path.

We make several major changes on top of Dashing1. First, Dashing2 follows the two-phase commit rule that if a replica receives a rQC for both a block b and b' (the parent block of b), block b' can be committed. Second, if a replica p_i receives a sQC for block b from the leader in normal case operation, p_i directly commits b and delivers the transactions unless b extends a block with a wQC. Third, during view change, the NEW-VIEW message from the new leader includes a set of at least $n - f$ VIEW-CHANGE messages. Upon receiving the NEW-VIEW message with a proposal, a correct replica verifies the proposal by performing a computation as the one used by the new leader to create the proposal. Replicas resume normal operations only after the NEW-VIEW message is verified. Finally, for the first block b proposed after each view change, the leader form a rQC rather than wQC or sQC for b to start the normal case operations.

Note that as in BFT protocols using strong quorums [2], [3], [21], Dashing2 does not achieve optimistic responsiveness (which is unavoidable due to the one-phase fast path). We show the pseudocode of Dashing2 and proof of correctness in Appendix C.

4. The Star Framework

We present Star, a new BFT framework that allows replicas to concurrently propose transactions and at least $n - f$ proposals will be delivered in each epoch.

4.1. Overview of the Star Architecture

As in Narwhal and Tusk [13], the transmission and consensus processes in Star (as described in Fig. 9) are decoupled. The transmission process is fully parallelizable and works in asynchronous environments. It proceeds in

epochs, where all replicas can propose transactions and output a queue of weak certificates numbered by epochs. The consensus process has only one BFT instance and does not carry bulk data. It takes as input weak certificates of the proposals and agrees on which proposals in each epoch should be delivered.

Compared to prior works, Star has the following distinctive features: 1) we use *pipelining* for the data transmission process to gain in efficiency; 2) Star uses wQCs for the data transmission process to further improve performance; 3) crucially, the transmission process and the consensus process are implicitly "correlated" with epoch numbers, and the consensus process only handles messages transmitted in the same epoch, which helps achieve effective censorship resilience and improve *blockchain quality*; 4) Star admits a more efficient and $O(1)$ time state transfer mechanism; and 5) Star has lower communication in both the gracious and uncivil scenarios than existing ones.

4.2. Star Details

The transmission process. The transmission process evolves in epochs. Each epoch consists of n parallel wCBC instances, as shown in Fig. 9 (a). Each replica maintains a queue Q of pending transactions and outputs a growing set $W[e]$ containing weak certificates for each epoch e . In each wCBC instance, a designated replica broadcasts a proposal (a batch of transactions) from its queue of pending transactions. Upon completing $n - f$ wCBC instances, each replica starts the next epoch and continues to propose new transactions.

wCBC may be viewed as a weak version of consistent broadcast (CBC), i.e., CBC with weak certificates. A wCBC instance consists of three steps. First, a designated sender sends a proposal containing a set of transactions to all replicas. The sender waits for signed responses from $f + 1$ replicas to form a wQC and sends it to all replicas. Upon receiving a valid wQC, each replica delivers the corresponding proposal. Note it is possible that for a particular wCBC instance, a correct replica delivers m and another correct replica delivers $m' \neq m$. While multiple conflicting wQCs might be provided by a faulty sender, we can trivially solve the issue by asking each replica to deliver only the first wQC for each epoch.

So why wCBC? wCBC ensures that if a wQC is formed, at least one correct replica has received and stored the corresponding proposal. The use of wQCs is *sufficient* to ensure liveness, because any replica p_j , once obtaining wQC, can ask for the corresponding proposal from correct replicas; any correct replica that stores the proposal can simply send it to p_j that can validate the correctness of the proposal via the wQC. The above procedure is needed only when a correct replica stored a wQC but had no corresponding proposal. Even if the scenario occurs, it would not incur higher message or communication complexity.

Star develops the above idea and offers a pipelined version for high performance. Concretely, each replica can directly propose a new proposal in the third step of wCBC.

We describe the code of the transmission process in Algorithm 4, where each replica p_i ($i \in [0..n - 1]$) runs the *initepoch*(e) function to start a new epoch e . Replica p_i chooses a set of transactions from Q as a proposal (say, b) using the *select* function. (The *select* function is vital to liveness and we will discuss its specification shortly.) It then broadcasts a message $\langle \text{PROPOSAL}, b, wqc \rangle$, where wqc is the wQC formed in epoch $e - 1$. (If we are working in the non-chaining mode, then wqc is simply \perp .) p_i waits for $f + 1$ votes for b to form a wQC. Then after receiving $n - f$ proposals for epoch e , p_i enters the next epoch $e + 1$. Upon receiving $\langle \text{PROPOSAL}, b_j, wqc_j \rangle$ from p_j , each replica first verifies wqc_j , sends a signed vote for b_j to p_j , adds b_j to *proposals*, and adds wqc_j to $W[e - 1]$.

Note we describe the code of the *obtain* function in the transmission process too, because only the transmission process has message queues. Jumping ahead, the *obtain* function takes as input wQCs *a-delivered* from the consensus process and outputs the corresponding proposals as delivered transactions.

Algorithm 4: The transmission process of Star (code shown for replica p_i ; the chaining (pipelined) mode)

```

1 initialization: epoch number  $e$ , queue  $Q$  of pending
  transactions, received proposals proposals, the latest weak
  certificate  $wqc$ , and queue  $W$  of weak certificates are all
  initialized to  $\perp$ .
2 func initepoch( $e$ )
3    $b.tx \leftarrow \text{select}(Q)$ ,  $b.epoch \leftarrow e$  //select a proposal  $b$  from  $Q$ 
4   broadcast  $\langle \text{PROPOSAL}, b, wqc \rangle$ 
   //broadcast the proposal and  $wqc$ ; pipelined mode
5   upon receiving a set  $M$  of  $f + 1$  signed votes for  $b$ 
6      $wqc \leftarrow \text{QCCREATE}(M)$  //create a weak certificate
7   wait until  $|\text{proposals}[e]| \geq n - f$  //enter the next epoch
8      $e \leftarrow e + 1$ , initepoch( $e$ )
9   upon receiving  $\langle \text{PROPOSAL}, b_j, wqc_j \rangle$  from replica  $p_j$  in  $e$  for
   the first time
10    send signed vote for  $b_j$  to  $p_j$ 
11     $\text{proposals}[e] \leftarrow \text{proposals}[e] \cup b_j$ 
12     $W[e - 1] \leftarrow W[e - 1] \cup wqc_j$  //certificates in the output queue

```

Algorithm 5: The consensus process of Star

```

1 initialization: the epoch number of the current block  $le$  is
  initialized to 1.  $W$  is the queue of wQCs obtained from the
  transmission process
2 upon  $|W[le]| \geq n - f$ 
3   a-broadcast( $W[le]$ ) //run the underlying atomic broadcast
4 upon a-deliver( $le, m$ )
5    $O \leftarrow \text{obtain}(le, m)$ 
6   deliver  $O$  //deliver the transactions in  $O$  in deterministic order
7    $le \leftarrow le + 1$ 

```

The consensus process. The consensus process also proceeds in epochs, using only one BFT instance to agree on the wQCs. We can use any BFT protocol for the consensus process. When describing the consensus process in Algorithm 5, we use the *a-broadcast* and *a-deliver* primitives in atomic broadcast.

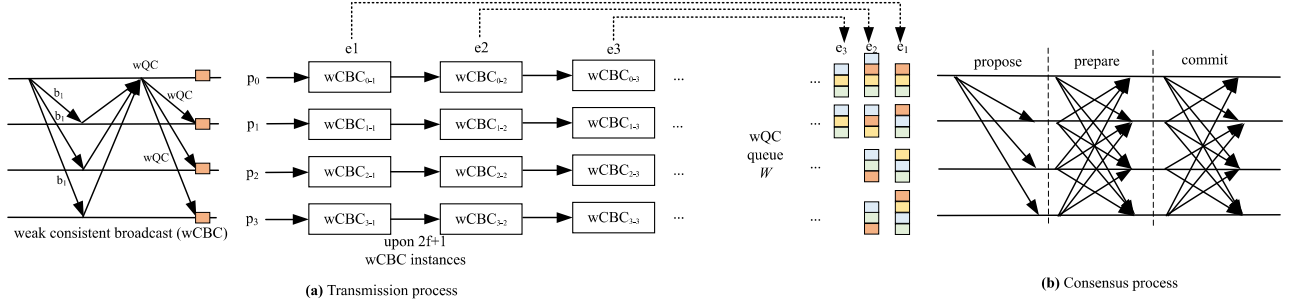

Figure 9: The Star architecture.

Algorithm 6: State transfer of Star

```

1 external: proposals,  $Q$  //obtained from the transmission process
2 func obtain( $e$ ,  $m$ )
   //obtain the union of proposals for a delivered message
3    $O \leftarrow \perp$  //to store delivered proposals
4   for wQC  $qc \in m$ 
5     if QCPROPOSAL( $qc$ )  $\in$  proposals[ $e$ ]
6       //already have the proposal
7        $O \leftarrow O \cup$  QCPROPOSAL( $qc$ )
8     else broadcast (FETCH,  $e$ ,  $qc$ )
9     wait for a PROPOSAL message containing
       QCPROPOSAL( $qc$ )
10     $O \leftarrow O \cup$  QCPROPOSAL( $qc$ )
11    clear  $W[e]$ , remove transactions in  $O$  from  $Q$ 
12    upon receiving message (FETCH,  $e$ ,  $qc$ ) from replica  $p_j$ 
13    if QCPROPOSAL( $qc$ )  $\in$  proposals[ $e$ ] //fetch missing proposals
       send (PROPOSAL, QCPROPOSAL( $qc$ )) to  $p_j$ 

```

Each replica p_i maintains le , a local parameter tracking the current consensus epoch number. p_i monitors its queue W (obtained from the transmission process) and checks whether $W[le]$ has at least $n - f$ weak certificates. If so, replicas run *a-broadcast*($W[le]$). (If the underlying BFT is leader-based, then only the leader proposes $W[le]$). When the *a-deliver* primitive terminates, each replica waits the transactions (from the transmission process) corresponding to wQCs a-delivered and delivers the transactions in deterministic order. If some proposals are missing, the replica may simply fetch the proposals from other replicas (via the state transfer process in Algorithm 6). In the state transfer protocol, for each wQC qc in epoch e , a replica p_i broadcasts a (FETCH, e , qc) message to all replicas. Upon receiving such a message, a replica sends the corresponding proposal to p_i if it has the proposal.

Censorship resilience (liveness) and blockchain quality. Protocols allowing all replicas to propose different transactions should address transaction censorship which prevents a particular transaction proposed by a replica from never being delivered. First, the use of wQC ensures that if the underlying atomic broadcast completes, then the corresponding proposal has been obtained by correct replicas, or can be obtained via the fetch operation by correct replicas.

We should in addition ensure that adversary cannot censor certain transactions. So we have to be careful in specifying the *select* function. HoneyBadgerBFT [32] invents a method that replicas randomly select transactions

from their queue and use threshold encryption to achieve censorship resilience. EPIC [27] combines the conventional FIFO strategy used in [9] and the random selection strategy used in HoneyBadgerBFT to avoid threshold encryption. The asynchronous pattern in Star allows us to adopt the same approach in EPIC and achieve liveness under asynchrony.

Our work enforces a strong form of *blockchain quality*, ensuring at least 1/2 of the total transactions contained in *any* committed block in an epoch are from correct replicas. Note that the concurrent work of Dumbo-NG does not satisfy this desirable feature: note the quality of the multi-valued Byzantine agreement (MVBA) in Dumbo-NG does not lead to blockchain quality.

Instantiating Star using PBFT. In Star, we use a variant of PBFT that is only slightly different from PBFT. First, as the proposed transactions are already assigned with epoch number in the transmission process, we directly use the epoch number as the *sequence* number in the consensus process. We additionally require that the leader cannot skip any epoch number. Last, during a view change, the new leader is not allowed to propose a nil block for any epoch number. Namely, for any epoch number e such that an agreement is not reached in a prior view, the new leader simply proposes $W[e]$. We describe the details of the protocol in Appendix D.

Complexity analysis. Star has n parallel wCBC and one instance of the underlying BFT protocol (say, PBFT, HotStuff), so Star has $O(n^2)$ messages (whether using PBFT or HotStuff). The communication complexity is $O(Ln^2 + \lambda n^2)$ for the transmission process and $O(\lambda n^2)$ for the consensus process. As a replica can directly obtains a proposal based on epoch number and each QC, for state transfer of multiple QCs, the time complexity is $O(1)$.

In contrast, Narwhal changes the reliable broadcast used in DAG-Rider to consistent broadcast and the change leads to a complex and expensive state transfer mechanism. In particular, to obtain the transactions for round r , a replica has to perform state transfer to obtain the corresponding block. Then based on the block, the replica obtains the list of certificates (for round $r - 1$) and then needs to perform state transfer for the corresponding blocks. This process repeats until the replica obtains the entire causal history. Each of these steps has to be executed one after another since there is no guarantee that at least one correct replica holds the entire causal history. Therefore, if a replica needs to perform state

transfer for k epochs in the transmission process, the time complexity is $O(k)$ while ours is $O(1)$. Moreover, Narwhal has $O(Ln^2 + \lambda n^3)$ communication, as each block consists of at least $2f + 1$ certificates of the prior round.

We prove the correctness of Star in Appendix E.

5. Implementation and Evaluation

We implement all our protocols introduced in this work and HotStuff in Golang using around 12,000 LOC, including 1,500 LOC for evaluation. We implement the chaining (pipelining) mode for the Dashing protocols and HotStuff. For all the protocols, we implement the checkpoint protocol for garbage collection, where replicas run the checkpoint protocol every 5000 blocks. We use gRPC as the underlying communication library. As in prior works [40], [34], [19], [1], we use digital signatures for quorum certificates. In particular, we use SM2 signature (ISO standard) which has similar performance as ECDSA. We also evaluate the performance of Narwhal [13] using their source code ².

We deploy the protocols in a local cluster with 40 servers (LAN) and also Amazon EC2 with up to 100 instances where the servers are evenly distributed across five continents (WAN). In the LAN setting, each server has a 16-core 2.3GHz CPU and 128 GB RAM in the cluster. The network round-trip time between two servers is on average 2 ms. The network bandwidth is 200 Mbps. In the WAN setting, we use *m5.xlarge* instance which has four virtual CPUs and 16 GB memory. Throughout the paper, we use different distributions of the instances to understand the protocol performance under network connection discrepancies (see Fig. 1 in the introduction). This section focuses on the setting where the servers are eventually distributed in four different regions: us-west-1 (California, US), us-east-2 (Ohio, US), ap-southeast-1 (Singapore), and eu-west-1 (Ireland).

For each experiment, we use $3f + 1$ replicas and use f to denote the network size. Unlike some existing experiments where the replicas generate client requests, we use real VMs to simulate the clients. We ask the clients to submit requests to the system in a non-closed loop, i.e., a client does not have to wait for the reply before sending the next request. Our experiments thus provide more realistic performance evaluation. We set the size for transactions and replies as 512 bytes. For the choice of Δ_2 , we set it as $\frac{\Delta_r - \Delta_w}{2}$, where Δ_r is the average latency for the leader to collect a rQC and Δ_w is the average latency for the leader to collect a wQC. Doing so allows us to obtain reasonable fractions of wQCs and rQCs in Dashing protocols.

Performance (latency vs. throughput; throughput). We report the performance of Dashing1, Dashing2, Star, HotStuff, and Narwhal in both LAN (our local cluster) and WAN (cloud) settings. For latency, we measure the average consensus time on the server side for each proposed block to be committed.

In the LAN setting, we report latency vs. throughput for $f = 1$ and $f = 10$ in Fig. 10a and Fig. 10b and throughput as the number of clients increases in Fig. 10c and Fig. 10d. Dashing1 and Dashing2 consistently outperform HotStuff. For instance, the peak throughput of Dashing1 is 11.3% higher and 5.07% higher than HotStuff for $f = 1$ and $f = 10$, respectively. Meanwhile, Star significantly and consistently outperforms other protocols. For $f = 1$ and $f = 10$, the peak throughput of Star is 3.25x and 9.19x the throughput of HotStuff, respectively. Star also outperforms Narwhal consistently. Compared to that of Narwhal, the peak throughput of Star is 1.35% higher for $f = 1$ and 37.2% higher for $f = 10$.

In the WAN setting, we report the performance of the protocols in Fig. 10e-10l. Both Dashing protocols consistently outperform HotStuff, while Star significantly outpaces Narwhal. For instance, the peak throughput of Dashing1 is 107.36% higher and 49.8% higher than that of HotStuff for $f = 1$ and $f = 30$, respectively. Furthermore, when $f = 30$, Star achieves 35.9x the throughput of HotStuff, 23.9x the throughput of Dashing1, and 2.38x the throughput of Narwhal.

While Dashing1 and Dashing2 provide some interesting performance trade-offs, they offer similar throughput in most of the experiments. But Dashing2 has a fast path in the failure-free scenario, having lower latency in most cases.

Scalability. We report in Fig. 3 the peak throughput of Dashing1, Dashing2, Star, and HotStuff in the WAN environment as f grows. All the Dashing protocols outperform HotStuff consistently. The peak throughput of Dashing1 is 47%-107% higher than that of HotStuff.

For Dashing protocols and HotStuff, the throughput degrades as f grows, echoing other protocols in the HotStuff family. The throughput of Narwhal first increases as f grows and then decreases as f grows further, matching the evaluation result reported in Narwhal [13].

In comparison, the peak throughput of Star keeps growing as f increases (to 30). In particular, the performance of Star for $f = 30$ is 3.84x the throughput for $f = 1$. Meanwhile, the peak throughput of Star consistently outperforms other protocols. When $f = 30$, the peak throughput of Star is 243 ktx/sec, in contrast to 7 ktx/sec for HotStuff, 10 ktx/sec for Dashing1, and 102 ktx/sec for Narwhal. This is mainly because: 1) replicas only agree on a set of wQCs; 2) all n replicas propose transactions concurrently and the transmission process and consensus process are fully decoupled but implicitly correlated using epoch numbers; 3) the transmission process is highly efficient and can be pipelined. We comment that by asking the consensus processes to process the transactions transmitted with the same epoch number, Star can ensure $O(1)$ time delivery. Note that both Star and Narwhal employ leaderless approaches for transmission of block proposals, each replica in Star only needs to collect $f + 1$ instead of $2f + 1$ matching votes. In a large-scale network, the overhead of collecting an additional f matching votes is high. This validates our motivation that wQC can be used to achieve higher efficiency.

Performance under failures. We assess the performance

2. <https://github.com/MystenLabs/narwhal>

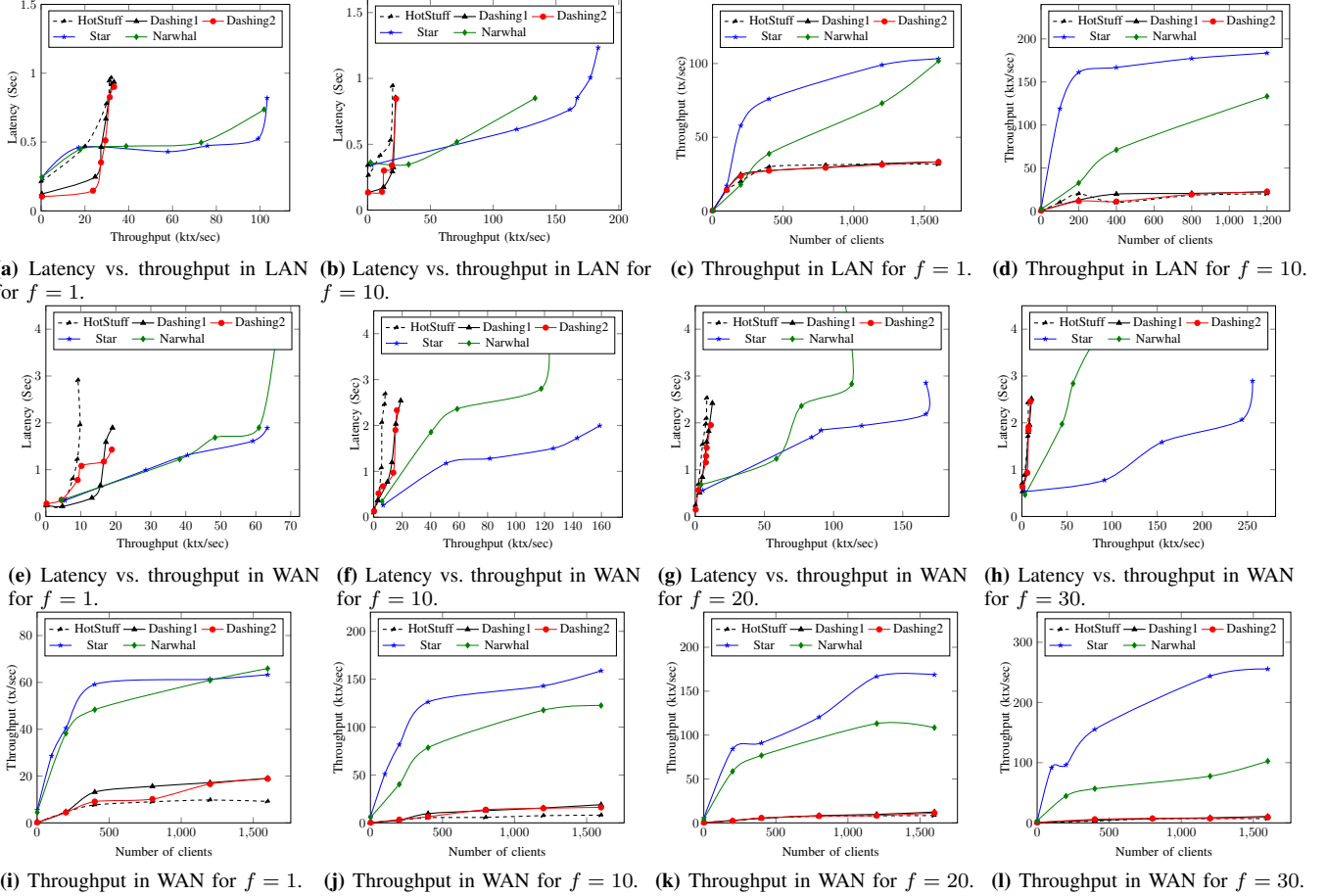

Figure 10: Performance of the protocols. Figures that compare only Dashing protocols and HotStuff are presented in Appendix A.

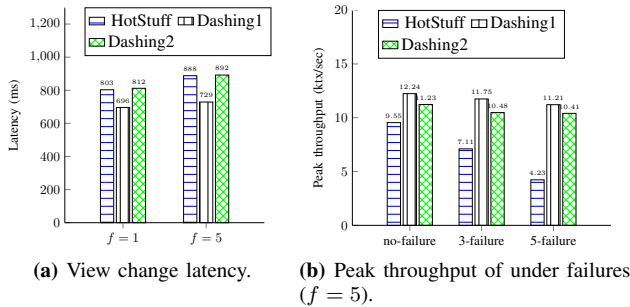

Figure 11: View change and performance under failures.

under failures for Dashing1, Dashing2, and HotStuff. We use 1200 clients in all the experiments.

We first assess the average latency of view changes due to the leader failures, where we halt the leader in the middle of each experiment. We report the view change latency for $f = 1$ and $f = 5$ in Fig. 11a. In our experiments, the view change latency for Dashing2 is higher than Dashing1 and HotStuff, mostly because each NEW-VIEW message consists of $n - f$ messages and replicas need to verify the messages accordingly.

We also report the peak throughput for $f = 5$ with backup replica failures in Fig. 11b, where we evaluate the case of no failures, three failures, and five failures, respectively. For the case with three failures, we halt one server in each of the us-east-2, ap-southeast-1, and eu-west-1 regions. For the case with five failures, we halt two replicas in the eu-west-1 region, and one replica in each of the other three regions. For the case of failures, the performance of HotStuff degrades dramatically. In contrast, the Dashing protocols are highly robust against crash failures. Indeed, during failures, the leader in HotStuff always needs to collect $n - f$ votes from the remaining correct replicas; but the Dashing protocols can exploit wQCs and maintain consistent performance.

6. Additional Related Work

Much related work is discussed in the course of the paper. Here we discuss additional related work.

HotStuff and its derivatives. HotStuff [40] is known as the first partially synchronous BFT protocol with linearity. HotStuff has three round-trips for both normal case operations and view changes. Subsequent works focus on reducing the number of phases for HotStuff, including Fast-HotStuff [24],

Jolteon [18], Wendy [19], and Marlin [39]. HotStuff has a basic mode and a chained (pipelining) mode (called chained HotStuff). The protocols introduced and implemented in this paper are described in their chained mode.

Protocol switching in BFT protocols. Following the idea initially proposed by Kursawe and Shoup [26], Bolt-Dumbo [29] and Ditto [18] run partially synchronous BFT protocols in the optimistic mode and rely on fallback asynchronous protocols during asynchrony [26]. All known such BFT protocols lack an effective mechanism to decide when to switch from the pessimistic mode to the optimistic mode, as it is (often) unpredictable when the network becomes synchronous again. The situation is only exacerbated, if the network is intermittently synchronous or adaptively manipulated [32]. Meanwhile, systems have been proposed to allow switching among (restricted) BFT protocols [22], [4]. These protocols offer adaptive performance but (largely) inherit the issues of protocol switching [26], [29], [18].

Weak certificates for eventual consistency. Zeno[35] uses weak certificates to handle network partitions. It allows $f + 1$ replicas to make progress, including view changes. Zeno leverages a conflict-resolution mechanism to achieve eventual synchrony, a consistency goal that is much weaker than ours. In contrast, Dashing1 combines weak certificates and regular certificates to achieve standard BFT guarantees, additionally gaining in efficiency and robustness.

BFT with strong quorums. Strong quorums (with $3f + 1$ replicas) for consensus have been used in Zyzzyva [25] and FaB [31]. The protocols have been found to have errors [2] and then fixed [3]. The fixed algorithm is at the center of SBFT [21] which also features the usage of strong quorums. Dashing2 tackles the new and subtle challenges due to weak certificates and linear communication.

Multiple thresholds in a single timing model or two different timing models. Some Byzantine-resilient protocols such as UpRight [12], [23] study different thresholds for different correctness properties (e.g., different thresholds for safety and liveness) in a single timing model. Some other protocols, however, consider two different timing models. Most of these protocols (except XFT [28]) focus on the asynchronous-synchronous timing model [30], [33], [5], [6]. For instance, the recent work of Malkhi, Nayak, and Ren [30] and the work of Momose and Ren [33] consider these two timing models and separate thresholds for safety and liveness properties. In contrast, XFT considers the partially synchronous-synchronous timing model. XFT tolerates $f < n/2$ Byzantine failures under synchrony but no Byzantine failures under partial synchrony.

Our protocols are different from these protocols. Our protocols use a single timing model and assume the $n/3$ threshold for both safety and liveness. The different thresholds in our protocols are used to improve efficiency or robustness.

Leader replacement in ISS. Systems such as Mir-BFT [36] and the recent ISS [37] are beautiful and practical BFT systems aiming at running n parallel BFT instances for high throughput. Handling parallel transactions using n BFT instances in one epoch turns out to be challenging.

ISS can deliver transactions only when all BFT instances successfully terminate. The full paper of ISS [38] discusses how to select n correct leaders for each epoch during failures and attacks to ensure liveness. In particular, ISS proposes three different and mutually exclusive policies for leader replacement. These policies provide trade-offs in terms of performance and robustness. Instead, Star has one BFT instance and does not have to deal with the issues.

7. Conclusion

We design and implement efficient BFT protocols using weak certificates, including a family of two Dashing protocols that offer improved efficiency and robustness compared to HotStuff, and a new (asynchronous) BFT framework Star allowing processing parallel transactions using a single BFT instance. Via a deployment in both the LAN and WAN environments, we show that our protocols outperform existing ones. In contrast to existing protocols, the throughput of Star keeps increasing as n grows; in particular, in the WAN setting with 91 replicas across different continents, Star has a throughput of 243 ktx/sec, 35.9x the throughput of HotStuff and 2.38x the throughput of Narwhal.

References

- [1] HotStuff (Relab). <https://github.com/relab/hotstuff>, 2022.
- [2] I. Abraham, G. Gueta, D. Malkhi, L. Alvisi, R. Kotla, and J.-P. Martin. Revisiting fast practical Byzantine fault tolerance. *arXiv preprint arXiv:1712.01367*, 2017.
- [3] I. Abraham, G. Gueta, D. Malkhi, and J.-P. Martin. Revisiting fast practical byzantine fault tolerance: Thelma, velma, and zelma. *arXiv preprint arXiv:1801.10022*, 2018.
- [4] J.-P. Bahsoun, R. Guerraoui, and A. Shoker. Making BFT protocols really adaptive. In *IPDPS*, pages 904–913. IEEE, 2015.
- [5] E. Blum, J. Katz, and J. Loss. Synchronous consensus with optimal asynchronous fallback guarantees. In *Theory of Cryptography Conference*, pages 131–150. Springer, 2019.
- [6] E. Blum, C.-D. Liu-Zhang, and J. Loss. Always have a backup plan: fully secure synchronous mpc with asynchronous fallback. In *Annual International Cryptology Conference*, pages 707–731. Springer, 2020.
- [7] A. Boldyreva. Threshold signatures, multisignatures and blind signatures based on the gap-diffie-hellman-group signature scheme. In *PKC*, pages 31–46, 2003.
- [8] D. Boneh, B. Lynn, and H. Shacham. Short signatures from the weil pairing. *Journal of cryptology*, 17(4):297–319, 2004.
- [9] C. Cachin, K. Kursawe, F. Petzold, and V. Shoup. Secure and efficient asynchronous broadcast protocols. In *Annual International Cryptology Conference*, pages 524–541. Springer, 2001.
- [10] C. Cachin and M. Vukolić. Blockchain consensus protocols in the wild. In *DISC*, pages 1:1–1:16, 2017.
- [11] M. Castro and B. Liskov. Practical byzantine fault tolerance and proactive recovery. *TOCS*, 20(4):398–461, 2002.
- [12] A. Clement, M. Kapritsos, S. Lee, Y. Wang, L. Alvisi, M. Dahlin, and T. Riche. Upright cluster services. In *Proceedings of the ACM SIGOPS 22nd symposium on Operating systems principles*, pages 277–290, 2009.
- [13] G. Danezis, L. Kokoris-Kogias, A. Sonnino, and A. Spiegelman. Narwhal and tusk: a dag-based mempool and efficient bft consensus. In *Proceedings of the Seventeenth European Conference on Computer Systems*, pages 34–50, 2022.

- [14] S. Duan and H. Zhang. PACE: Fully parallelizable BFT from reproposable byzantine agreement. *IACR Cryptol. ePrint Arch.*, 2022.
- [15] C. Dwork, N. Lynch, and L. Stockmeyer. Consensus in the presence of partial synchrony. *Journal of ACM*, 32(2):288–323, 1988.
- [16] M. J. Fischer, N. A. Lynch, and M. S. Paterson. Impossibility of distributed consensus with one faulty process. Technical report, Massachusetts Inst of Tech Cambridge lab for Computer Science, 1982.
- [17] Y. Gao, Y. Lu, Z. Lu, Q. Tang, J. Xu, and Z. Zhang. Dumbo-ng: Fast asynchronous bft consensus with throughput-oblivious latency. *arXiv preprint arXiv:2209.00750*, 2022.
- [18] R. Gelashvili, L. Kokoris-Kogias, A. Sonnino, A. Spiegelman, and Z. Xiang. Jolteon and ditto: Network-adaptive efficient consensus with asynchronous fallback. *arXiv preprint arXiv:2106.10362*, 2021.
- [19] N. Girdharan, H. Howard, I. Abraham, N. Crooks, and A. Tomescu. No-commit proofs: Defeating livelock in bft. *Cryptology ePrint Archive*, 2021.
- [20] N. Girdharan, L. Kokoris-Kogias, A. Sonnino, and A. Spiegelman. Bullshark: Dag bft protocols made practical. *arXiv preprint arXiv:2201.05677*, 2022.
- [21] G. Golan-Gueta, I. Abraham, S. Grossman, D. Malkhi, B. Pinkas, M. K. Reiter, D. Seredinschi, O. Tamir, and A. Tomescu. SBFT: A scalable and decentralized trust infrastructure. In *DSN*, pages 568–580, 2019.
- [22] R. Guerraoui, N. Knežević, V. Quéma, and M. Vukolić. The next 700 bft protocols. *ACM Transactions on Computer Systems*, 32(4):12:1–12:45, 2015.
- [23] M. Hirt, A. Kastrati, and C. Liu-Zhang. Multi-threshold asynchronous reliable broadcast and consensus. In *24th International Conference on Principles of Distributed Systems*, 2020.
- [24] M. M. Jalalzai, J. Niu, C. Feng, and F. Gai. Fast-hotstuff: A fast and resilient hotstuff protocol. *arXiv preprint arXiv:2010.11454*, 2021.
- [25] R. Kolta, L. Alvisi, M. Dahlin, A. Clement, and E. Wong. Zyzzyva: speculative byzantine fault tolerance. *ACM Transactions on Computer Systems*, 27(4):7:1–7:39, 2009.
- [26] K. Kursawe and V. Shoup. Optimistic asynchronous atomic broadcast. In *ICALP*, pages 204–215, 2005.
- [27] C. Liu, S. Duan, and H. Zhang. Epic: Efficient asynchronous bft with adaptive security. In *DSN*, 2020.
- [28] S. Liu, P. Viotti, C. Cachin, V. Quéma, and M. Vukolic. XFT: Practical fault tolerance beyond crashes. In *OSDI*, pages 485–500, 2016.
- [29] Y. Lu, Z. Lu, and Q. Tang. Bolt-dumbo transformer: Asynchronous consensus as fast as pipelined bft. In *CCS*, 2022.
- [30] D. Malkhi, K. Nayak, and L. Ren. Flexible byzantine fault tolerance. In *CCS*, pages 1041–1053, 2019.
- [31] J.-P. Martin and L. Alvisi. Fast byzantine consensus. *IEEE Transactions on Dependable and Secure Computing*, 3(3):202–215, 2006.
- [32] A. Miller, Y. Xia, K. Croman, E. Shi, and D. Song. The honey badger of bft protocols. In *Proceedings of the SIGSAC Conference on Computer and Communications Security*, pages 31–42. ACM, 2016.
- [33] A. Momose and L. Ren. Multi-threshold byzantine fault tolerance. In Y. Kim, J. Kim, G. Vigna, and E. Shi, editors, *CCS*, pages 1686–1699. ACM, 2021.
- [34] R. Neiheiser, M. Matos, and L. Rodrigues. Kauri: Scalable bft consensus with pipelined tree-based dissemination and aggregation. In *SOSP*, pages 35–48, 2021.
- [35] A. Singh, P. Fonseca, P. Kuznetsov, R. Rodrigues, and P. Maniatis. Zeno: Eventually consistent byzantine-fault tolerance. *NSDI’09*, 2009.
- [36] C. Stathakopoulou, T. David, and M. Vukolic. Mir-bft: High-throughput bft for blockchains. *arXiv preprint arXiv:1906.05552*, 2019.
- [37] C. Stathakopoulou, M. Pavlovic, and M. Vukolić. State machine replication scalability made simple. In *Proceedings of the Seventeenth European Conference on Computer Systems*, pages 17–33, 2022.
- [38] C. Stathakopoulou, M. Pavlovic, and M. Vukolić. State-machine replication scalability made simple (extended version). *arXiv preprint arXiv:2203.05681*, 2022.
- [39] X. Sui, S. Duan, and H. Zhang. Marlin: Two-phase bft with linearity. *DSN*, 2022.
- [40] M. Yin, D. Malkhi, M. K. Reiter, G. G. Gueta, and I. Abraham. Hotstuff: Bft consensus with linearity and responsiveness. In *PODC*, 2019.

Appendix A. Additional Evaluation Results

We report evaluation results for Dashing1, Dashing2, and HotStuff with enlarged figures in Fig. 12.

Appendix B. Correctness of Dashing1

We first introduce some notation we use in this section. Let b', b denote two blocks such that $b.parent = b'$. According to Algorithm 2 and Algorithm 3, after receiving a GENERIC message $\langle \text{GENERIC}, b, qc \rangle$, a correct replica votes for b only if (1) $b.stable = b'$ and qc is a rQC for b' (In 17-19 of Algorithm 2 and In 15 of Algorithm 3); or (2) $b.stable = b'.stable$ and qc is a wQC for b' (In 16 of Algorithm 2 and In 14 of Algorithm 3). In both cases, we say that qc and b are *matching*.

Let b, b' and b'' denote three consecutive blocks. In Algorithm 1, we have that a replica p_i commits b only after receiving a rQC qc for b'' such that $b''.stable = b'$, $b'.stable = b$, and $b.view = b'.view = b''.view = v$. In this case, we call qc a *commitQC* for b .

Lemma B.1. *If b and d are two conflicting blocks and $rank(b) = rank(d)$, then a rQC cannot be formed for both b and d .*

Proof. Let v denote $b.view$. As $rank(b) = rank(d)$, we have $d.view = v$. Suppose, towards a contradiction, a rQC is formed for both b and d . As a valid rQC consists of $2f + 1$ votes, a correct replica has voted for both b and d in view v . This causes a contradiction, because a correct replica votes for at most one block with each height in the same view. \square

Lemma B.2. *Suppose that there exists a rQC or a wQC qc for b ; block d and d_c are on the branch led by b such that $d_c.parent = d$, then we have that*

(1) *$d.height < d_c.height$ and at least one correct replica has received a certificate qc_d for d , where qc_d and d_c are matching;*

(2) *and if the view of the parent block of d is lower than $d.view$, then at least one correct replica has received a rQC qc_d for d and $d_c.stable = d$.*

Proof. (1) We prove the claim (1) by induction for d . If $d = b.parent$, then d_c equals b . Since qc is a rQC or a wQC for b , at least one correct replica has voted for d_c . Then we

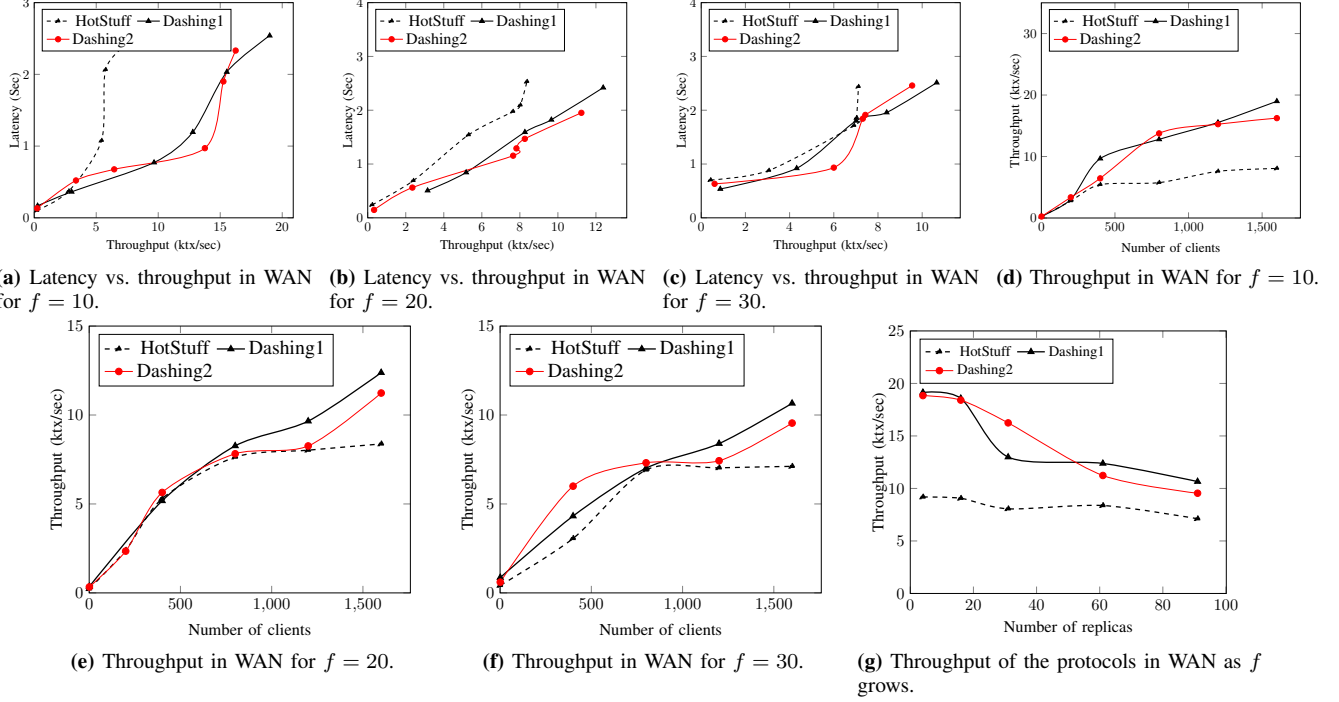

Figure 12: Evaluation results for Dashing1, Dashing2, and HotStuff with enlarged figures.

have that $d.height < d_c.height$ and p_i has received a qc_d before voting for d_c , where qc_d and d_c are matching.

If $d \neq b.parent$, then there exists a rQC or a wQC for any block higher than d on the branch led by b . In this situation, there exists a block d_c on the branch led by b such that $d_c.parent = d$; a rQC or a wQC qc_c for d_c is received by at least one correct replica. Since qc_c consists of at least $f + 1$ votes, at least one correct replica p_i has voted for d_c in view $d_c.view$. Then we have that $d.height < d_c.height$ and p_i has received a qc_d before voting for d_c , where qc_d and d_c are matching. This completes the proof of claim (1).

(2) Based on claim (1), we know that at least one correct replica p_i has voted for d_c in view $d_c.view$. Let d' denote the parent block of b . Then $d'.view < d.view$. According to ln 16-18 of Algorithm 2, p_i votes for d_c only if p_i has received a rQC qc_d for d and $d_c.stable = d$. \square

Lemma B.3. *If there exists a wQC qc_d for block d , then d extends $d.stable$ and a rQC for $d.stable$ has been received by at least one correct replica.*

Proof. Let d_0 denote $d.parent$. As there exists a wQC for d , at least one correct replica p_i has received a certificate qc and voted for d in view $d.view$, where qc and d are matching. We distinguish two cases:

(1) qc is a rQC for d_0 and $d.stable = d_0$. Then we know that d extends $d.stable$, because d_0 is the parent block of d . Accordingly, at least one correct replica p_i has received a rQC qc for $d.stable$ before voting for d .

(2) qc is a wQC for d_0 and $d.stable = d_0.stable$. Let d_v denote the block with the highest height on the branch led by d such that $d_v.stable \neq d.stable$. Let d'_v

denote the block on the branch such that $d'_v.parent = d_v$. We have $d'_v.height > d_v$ and $d'_v.stable = d.stable$. Therefore, at least one correct replica p_i has voted for d'_v from Lemma B.2. Thus, we have $d'_v.stable = d_v.stable$ or $d'_v.stable = d_v$ according to Algorithm 2 (ln 16-18). Since $d_v.stable \neq d.stable$, $d'_v.stable \neq d_v.stable$. Then we know that $d'_v.stable = d.stable = d_v$ and d extends $d.stable$. Meanwhile, p_i has received a rQC for d_v before voting for d'_v .

In both cases, d extends $d.stable$ and a correct replica has received a rQC for $d.stable$. \square

Lemma B.4. *If there exists at least one rQC formed in view v , then there exists only one rQC qc with the lowest rank in view v , and we have that*

- (1) *The view of $b.parent$ is lower than v , where b be $QCBLOCK(qc)$;*
- (2) *If there exists a rQC for b_1 and $b_1.parent.view < v$, then b_1 equals b .*

Proof. If a rQC is formed in view v , then there exists only one rQC qc with the lowest rank in view v (according to Lemma B.1).

(1) Let b denote $QCBLOCK(qc)$ and b_v denote the block with the lowest height such that $b_v.view = v$ on the branch led by b . Therefore, $b_v.height \leq b.height$ and the view of $b_v.parent$ is lower than v . According to Lemma B.2, there must exist a rQC for b_v . Since qc is the lowest rQC formed in view v , we have that $b_v = b$ and the view of $b.parent$ is lower than v .

(2) If there exists a rQC for b_1 , then at least a correct replica has voted for b_1 and b in view v . Note that in view

v , a correct replica only votes for one block that extends a block proposed in a lower view according to Algorithm 3. Therefore, it must hold that $b_1 = b$. \square

Lemma B.5. *If rQC qc for b is the rQC with the lowest height formed in view v and there exists a rQC for block d such that $d.view = v$, then d equals b or d is an extension of b .*

Proof. Let d_0 denote the block with the lowest height on the branch led by d such that $d_0.view = v$. Then the view of the parent block of d_0 is lower than v . According to Lemma B.2, at least one correct replica has received a rQC for d_0 . By Lemma B.4, it holds that d_0 equals b . As d_0 is a block on the branch led by d , d equals b or d is an extension of b . \square

Lemma B.6. *Suppose qc_1 and qc_2 are two rQCs, each is received by at least one correct replicas. Let b_1 and b_2 be $QCBLOCK(qc_1)$ and $QCBLOCK(qc_2)$, respectively. If b_1 is conflicting with b_2 , then $b_1.view \neq b_2.view$.*

Proof. Assume, towards a contradiction, that $b_1.view = b_2.view = v$. According to Lemma B.5, we know that there exists a block b which is the block with the lowest height for which a rQC was formed in view v , b_1 and b_2 are blocks and either b_1 or b_2 equals b or is an extensions of b . Then $b_1.height \geq b.height$ and $b_2.height \geq b.height$. We consider three cases:

(1) If $b_1.height = b.height$ or $b_2.height = b.height$, then b_1 equals b or b_2 equals b . Therefore, b_1 and b_2 are the same block or they are on the same branch.

(2) If $b.height < b_1.height$, $b.height < b_2.height$, and $b_1.height = b_2.height$, then according to Lemma B.1, b_1 and b_2 must be the same block.

(3) If $b.height < b_1.height$, $b.height < b_2.height$, and $b_1.height \neq b_2.height$, then b_1 and b_2 are extensions of b . W.l.o.g., we assume that $b_1.height < b_2.height$. Let b'_2 denote a block on the branch led by b_2 such that $b'_2.height = b_1.height$. Then b'_2 is an extension of b . If b'_2 is conflicting with b_1 , then according to Lemma B.1, we have that no rQC for b'_2 can be formed in view v and at most f correct replicas voted for b'_2 . Thus, a rQC for any extensions of b'_2 cannot be formed by Algorithm 2. Therefore, we have that b'_2 must be equal to b_1 .

In all cases, b_1 and b_2 must be blocks on the same branch, contradicting the condition that they are conflicting blocks. Therefore, we have that $b_1.view \neq b_2.view$. \square

Lemma B.7. *If there exists a commitQC qc for b and a rQC qc_d for d , each is received by at least correct replica, and $rank(b) < rank(d)$, then d must be an extension of b .*

Proof. Let v denote $b.view$, v_d denote $d.view$, b'' denote $QCBLOCK(qc)$, and b' denote $b''.parent$. As qc is a commitQC for b , we have that $b'.stable = b'.parent = b$, $b''.stable = b'$, and $b.view = b'.view = b''.view = v$. According to Lemma B.2, there exist rQCs for b, b' , and b'' such that all these rQCs are received by at least one correct replica. Note that a rQC for b' is also a lockedQC for b . Let

S denote the set of correct replicas that have voted for b'' . Since qc consists of $2f+1$ votes, we know that $|P| \geq f+1$.

Since $rank(d) > rank(b)$, $v_d \geq v$. Then we prove the lemma by induction over the view v_d , starting from view v .

Base case: Suppose $v_d = v$. According to Lemma B.6, d must be an extension of b .

Inductive case: Assume this property holds for view v_d from v to $v+k-1$ for some $k \geq 1$. We now prove that it holds for $v_d = v+k$. Let b_0 denote the block with the lowest height for which a rQC qc_0 was formed in view v_d and b'_0 denote $b_0.parent$. Let m denote the GENERIC message for b_0 . According to Lemma B.4, $b'_0.view < v_d$ and b_0 is proposed during view change. Since qc_0 consists of $2f+1$ votes, at least one replica $p_i \in S$ has voted for b_0 in view v_d . Let b_{lock} denote the locked block lb of p_i when voting for b_0 . Note that p_i updates its lb only after receiving a lockedQC for a block with a higher rank than its locked block. Then we know that $rank(b_{lock}) \geq rank(b)$. Note that $b_{lock}.view < v_d$. According to Lemma B.6 and the inductive hypothesis, b_{lock} must be either equal to b or an extension of b . Then p_i votes for b_0 only if one of the following conditions is satisfied:

- 1) $b_0.stable = b'_0.stable$, $m.justfy$ is a wQC for b'_0 , $b'_0.view < v_d$ and $rank(b'_0.stable) \geq rank(b_{lock})$ (In 14 in Algorithm 3).
- 2) $b_0.stable = b'_0$, $m.justfy$ is a rQC for b'_0 , $b'_0.view < v_d$, and $rank(b'_0) \geq rank(b_{lock})$ (In 15 in Algorithm 3).

If condition 1) is satisfied, then according to Lemma B.3, b'_0 is an extension of $b'_0.stable$ and at least one correct replica has received a rQC for $b'_0.stable$. Note that $rank(b'_0.stable) \geq rank(b_{lock})$. According to Lemma B.1 and the inductive hypothesis, $b'_0.stable$ is equal to b or an extension of b . Hence, b_0 must be an extension of b .

If condition 2) is satisfied, then $rank(b'_0) \geq rank(b_{lock}) \geq rank(b)$ and $m.justify$ is a rQC for b'_0 . According to Lemma B.1 and the inductive hypothesis, b'_0 is either equal to b or an extension of b .

Either way, b_0 must be an extension of b . Note that a rQC for d is formed in view v_d . According to Lemma B.5, we know that d is equal to b_0 or an extension of b_0 . Therefore, d must be an extension of b and the property holds in view $v+k$. This completes the proof of the lemma. \square

Theorem B.1. (safety) *If b and d are conflicting blocks, then they cannot be committed each by at least a correct replica.*

Proof. Suppose that a commitQC is formed for both b and d . According to Lemma B.2, there must exist rQCs for both b and d , each received by at least one correct replica. If $b.view = d.view$, then according to Lemma B.6, rQCs for both b and d cannot be formed. If $b.view \neq d.view$, w.l.o.g., we assume that $rank(b) < rank(d)$. According to Lemma B.7, a rQC for d cannot be formed in view $d.view$. Hence, no commitQC for d can be formed in view $d.view$. In both cases, commitQC for both b and d cannot be formed. \square

Theorem B.2. (liveness) *After GST, there exists a bounded time period T_f such that if the leader of view v is correct*

and all correct replicas remain in view v during T_f , then a decision is reached.

Proof. Suppose after GST, in a new view v , the leader p_i is correct. Then p_i can collect a set M of $2f + 1$ VIEW-CHANGE messages from correct replicas and broadcast a new block b in a message $m = \langle \text{GENERIC}, b, qc \rangle$.

Let b' denote $b.parent$. Let b_{high} denote the block with the highest rank locked by at least one correct replica. Note that a correct replica locks b_{high} only after receiving a lockedQC qc for it. Let b_1 denote $\text{QCBLOCK}(qc)$. Then we know that $b_1.parent = b_1.stable = b_{high}$ and a set S of at least $f + 1$ correct replicas have voted for b_1 . Therefore, at least one message in M is sent by a replica $p_j \in S$. According to Algorithm 2 and Algorithm 3, a correct replica votes for block b_1 only after receiving a rQC for b_{high} and QC_r of the replica is the rQC with the highest rank received by the replica. Thus, the rank of the rQC qc_j sent in VIEW-CHANGE message by p_j is no less than that of b_{high} . From Algorithm 3, there are two cases for b : (1) $b.stable = b'$, qc is a rQC for b' and $rank(qc) \geq rank(qc_j)$; (2) $b.stable = b'.stable$, qc is a wQC for b' and $rank(b'.stable) \geq rank(qc_j)$. In case (1), b will be voted by all the correct replicas as conditions on Ln 15 of Algorithm 3 are satisfied. In case (2), b will be voted by all the correct replicas as conditions on Ln 14 of Algorithm 3 are satisfied.

If all correct replicas are synchronized in their view, p_i is able to form a QC for b and generate new blocks. All correct replicas will vote for the new blocks proposed by p_i . Therefore a *commitQC* for b can be formed by p_i , leading to a new decision. Hence, after GST, the duration T_f for these phases to complete is of bounded length. This completes the proof of the theorem. \square

Appendix C. Dashing2

C.1. Dashing2 Details

Compared with Dashing1, a sQC is used as a certificate for a fast path in Dashing2. We present in Algorithm 8 and Algorithm 9 the normal case operation and view change protocol of Dashing2, respectively. The utility functions are presented in Algorithm 7. Dashing2 follows the notation of Dashing1. rQCs and sQCs are collectively called *qualified* QCs in this section.

Normal case protocol (Algorithm 8). Similar to Dashing1, in each phase, the leader broadcasts a block b in message $\langle \text{GENERIC}, b, qc_{high} \rangle$ to all replicas and waits for signed responses from replicas. qc_{high} is the last QC the leader receives (either a wQC, a rQC, or a sQC). After collecting $f + 1$ matching votes, the leader starts a timer Δ_2 (Ln 7). The timer is used to determine if the leader can form a rQC or a sQC in time. After Δ_2 expires, the leader combines the signatures in the votes into qc_{high} for the next phase.

Upon receiving a $\langle \text{GENERIC}, b, \pi \rangle$ message from the leader, each replica p_i first verifies whether b is well-formed

and proposed during normal operation (Ln 16-17), i.e., b has a higher rank than its parent block b' , $b.height = b'.height + 1$, b' and b are proposed in the same view. Let b'' denote the parent of b' . We distinguish two cases:

- If the π field is a wQC for b' (Ln 18), p_i verifies if the stable block of b and b' are the same block such that b indeed extends b' . p_i also verifies if b, b', b'' , and $b.stable$ are all proposed in the same view and p_i has previously voted for b' . If so, p_i updates its local parameter QC_w to π and creates a signature for b (Algorithm 7, Ln 13).
- If π is a rQC or a sQC for b' (Ln 21-22), p_i verifies if the stable block of b is b' , b' has a no lower rank than vb , and b' has a no lower rank than the QC_r of p_i . If so, p_i updates its local parameter QC_r to π and generates a signature (Algorithm 7, Ln 10 and Ln 15). If π is a rQC, b'' has a qualified QC, and b'' and b are proposed in the same view, then p_i commits block b'' and delivers transactions in b'' (Algorithm 7, Ln 11-12). If π is a sQC, b'' has a qualified QC, and b'' and b are proposed in the same view, then p_i commits block b' and delivers transactions in b' (Algorithm 7, Ln 14-15).

In both cases, the replica updates its vb to b , and sends its signature to the leader.

View change protocol (Algorithm 9). Every replica starts timer Δ_1 for the first transaction in its queue. If the transaction is not processed before Δ_1 expires, the replica triggers view change. In particular, the replica sends a $\langle \text{VIEW-CHANGE}, vb, (QC_r, QC_w) \rangle$ message to the leader (Algorithm 8, Ln 28). Upon receiving $n - f$ VIEW-CHANGE messages (denoted as M), the leader chooses a block to extend based on the output of $\text{SAFELOCK}(M)$ in Algorithm 7.

We now describe the procedure in more detail. Below, all number of lines is referred to as that in Algorithm 7. First, the leader obtains a block b_1 with a QC that has the highest rank (Ln 17-18). The leader then obtains a block b_0 with a wQC vc such that $b_0, b_0.parent$ and $b_0.stable$ are proposed in the same view, and among all the blocks with weak QCs, b_0 has the highest stable block (Ln 19-24). The leader also obtains block b_2 such that b_2 is contained in more than $f + 1$ VIEW-CHANGE messages in M . If no such block exists, b_2 is set to \perp (Ln 25-26). Then the leader checks if the rank of the stable block of b_2 is no less than that of b_1 (Ln 27). If so, the leader selects b_0 to extend. Otherwise, the leader checks if the rank of the stable block of b_0 is no less than that of b_1 (Ln 28). If so, the leader will extend b_0 . If neither is satisfied, the leader chooses b_1 to extend (Ln 29).

Then the leader extends the selected block with a block b and broadcasts b to the replicas (Ln 5 of Algorithm 9).

Upon receiving a $\langle \text{NEW-VIEW}, b, M \rangle$ message from a new leader, each replica p_i verifies b basing on the output of $\text{SAFELOCK}(M)$ (Ln 14-18). If b is a block extending the output block of $\text{SAFELOCK}()$, then p_i votes for b (Ln 16 and Ln 18).

C.2. Correctness of Dashing2

We first introduce some notation we use for the proof. Let b' and b denote two blocks such that $b.parent = b'$ and

Algorithm 7: Utilities for Dashing2

```
1 procedure CREATEBLOCK( $b', v, cmd, qc$ )
2    $b.pl \leftarrow hash(b'), b.parent \leftarrow b', b.req \leftarrow req,$ 
3    $b.height \leftarrow b'.height + 1, b.view \leftarrow v$ 
4   if  $qc$  is a wQC or  $\perp$  then  $b.sl \leftarrow b'.sl,$ 
    $b.stable \leftarrow b'.stable,$  return  $b$ 
5   if  $qc$  is a rQC or a sQC then  $b.sl \leftarrow hash(b')$  return  $b$ 
6   procedure STATEUPDATE( $QC_w, QC_r, qc$ )
7    $b' \leftarrow QCBLOCK(qc), b'' \leftarrow b'.parent,$ 
8    $b_0 \leftarrow QCBLOCK(QC_w), b_{high} \leftarrow QCBLOCK(QC_r)$ 
9   if  $qc$  is a rQC
10     $QC_r \leftarrow qc$ 
11    if  $b'.stable = b''$  and  $b'.view = b'.view$  then
12      deliver the transactions in  $b''$ 
13    if  $qc$  is a wQC then  $QC_w \leftarrow qc$ 
14    if  $qc$  is a sQC and  $b'.stable = b''$  and  $b'.view = b''.view$ 
15      then  $QC_r \leftarrow qc,$  deliver the transactions in  $b'$ 
16  procedure SAFEBLOCK( $M$ )
17   $qc_{high} \leftarrow$  the qualified QC with the highest rank contained
   in  $M$ 
18   $b_1 \leftarrow QCBLOCK(qc_{high}), b \leftarrow$ 
  CREATEBLOCK( $b_1, cview, req, qc_{high}$ )
19  for a wQC  $qc \in M.justify$ 
20     $d \leftarrow QCBLOCK(qc), d' \leftarrow d.parent, d_s \leftarrow d.stable$ 
21    if  $d_s.view = d'.view = d.view$ 
22      if  $rank(d_s) > rank(b_0.stable)$  then  $vc \leftarrow qc, b_0 \leftarrow d$ 
23      if  $rank(d_s) = rank(b_0.stable)$  and  $rank(d) >$ 
24         $rank(b_0)$  then  $vc \leftarrow qc, b_0 \leftarrow d$ 
25  for  $d \in M.block$ 
26    if  $num(d, M.block) \geq f + 1$  then  $b_2 \leftarrow d$ 
27  if  $rank(b_2.stable) \geq rank(b_1)$  then return  $(b_2, \perp)$ 
28  else if  $rank(b_0.stable) \geq rank(b_1)$  return  $(b_0, vc)$ 
29  return  $(b_1, qc_{high})$ 
```

$b'.view = b.view$. According to Algorithm 8, after receiving a GENERIC message $\langle \text{GENERIC}, b, qc \rangle$, a correct replica votes for b only if (1) $b.stable = b'$ and qc is a rQC or a sQC for b' (ln 21-23); or (2) $b.stable = b'.stable$ and qc is a wQC for b' (ln 18-20). In both cases, we say that qc and b are *matching*.

Let b' and b denote two consecutive blocks. In Algorithm 7, a replica p_i commits b only after receiving a certificate qc and one of the following condition is satisfied:

(1) qc is a rQC for b' such that $b'.stable = b'.parent = b$ and $b.view = b'.view$ (ln 9-12);

(2) qc is a sQC for b , $b.stable = b.parent$ and $b.parent.view = b.view$ (ln 14-15).

In both cases, qc is a *commitQC* for b .

Lemma C.1. *Suppose a block b has been voted by a correct replica, then*

(1) *any block d on the branch led by b has been voted by at least one correct replica and $d.parent.height + 1 = d.height$;*

(2) *if d and d_c are two blocks on the branch led by b such that $d_c.parent = d$ and $d_c.view = d.view = v$, then we have that (i) at least one correct replica has received a certificate (wQC, rQC, or sQC) qc_d for d , where qc_d and d_c are matching; (ii) if the view of the parent block of d is lower than v , then at least one correct replica has received a qualified QC for d and $d_c.stable = d$.*

Proof. Let d denote a block on the branch led by b .

Algorithm 8: Normal case protocol for Dashing2

```
1 initialization:  $cview \leftarrow 1, vb, QC_w,$  and  $QC_r$  are initialized to
 $\perp$ 
2 Start a timer  $\Delta_1$  for the first request in the queue of pending
  transactions
3 > GENERIC phase:
4 as a leader
5   wait for votes for  $b: M \leftarrow \{\sigma | \sigma \text{ is a signature for}$ 
    $\langle \text{GENERIC}, b, \perp \rangle\}$ 
6   upon  $|M| = f + 1$  then set a start timer  $\Delta_2$ 
7   upon  $\Delta_2$  timeout then  $qc_{high} \leftarrow QCCREATE(M)$ 
8    $b \leftarrow \text{CREATEBLOCK}(b, cview, cmd, qc_{high})$ 
9   broadcast  $m = \langle \text{GENERIC}, b, qc_{high} \rangle$ 
10  if  $qc_{high}$  is a wQC then  $QC_w \leftarrow qc_{high}$ 
11  if  $qc_{high}$  is a rQC or a sQC then  $QC_r \leftarrow qc_{high}$ 
12 as a replica
13  wait for  $m = \langle \text{GENERIC}, b, \pi \rangle$  from LEADER( $cview$ )
14   $b' \leftarrow b.parent, b'' \leftarrow b'.parent, b_s \leftarrow b.stable,$ 
15   $b_{gen} \leftarrow QCBLOCK(QC_r), m \leftarrow \langle \text{GENERIC}, b, \perp \rangle$ 
16  if  $rank(b') \geq rank(b)$  or  $b.height \neq b'.height + 1$  or
17     $b'.view \neq cview$  or  $b.view \neq cview$  then
18    discard the message
19  if  $\pi$  is a wQC for  $b'$  and  $b.sl = b'.sl$  and  $rank(b_s) \geq$ 
20     $rank(b_{gen})$  and  $b_s.view = b''.view = b'.view = cview$ 
21    and  $b' = vb$  then
22       $vb \leftarrow b, \text{STATEUPDATE}(QC_w, QC_r, \pi)$ 
23  if  $\pi$  is a rQC or a sQC for  $b'$  and  $b.stable = b'$ 
24    and  $rank(b') \geq rank(vb)$  and  $rank(b') \geq rank(b_{gen})$ 
25       $vb \leftarrow b, \text{STATEUPDATE}(QC_w, QC_r, \pi)$ 
26  if  $vb = b$  then send QCVOTE( $m$ ) to LEADER( $cview$ )
27 > NEW-VIEW phase: switch to this line if  $\Delta_1$  timeout occurs
28 as a replica
29    $cview \leftarrow cview + 1$ 
30   send  $\langle \text{VIEW-CHANGE}, vb, (QC_r, QC_w) \rangle$  to
   LEADER( $cview$ )
```

(1) We prove claim (1) by induction for d . If $d = b$, then d has been voted by at least one correct replica.

If $d \neq b$ and any block higher than d on the branch led by b has been voted by at least one correct replica, then we need to prove that d is voted by at least one correct replica. In this situation, there exists a block d_c on the branch led by b such that $d_c.parent = d$ and d_c has been voted by at least one correct replica p_i . According to Algorithm 2 and Algorithm 3, $rank(d) < rank(d_c)$ and $d_c.height = d.height + 1$. Therefore, $d.view \leq d_c.view$.

We now differentiate two cases: $d.view = d_c.view$ and $d.view < d_c.view$.

If $d.view = d_c.view$, then p_i has received a qc_d for d , where qc_d and d_c are matching according to Algorithm 8. As qc_d consists of at least $f + 1$ votes, at least one correct replica has voted for d and $d.parent.height + 1 = d.height$.

If $d.view < d_c.view$, then from Algorithm 9, we know that d_c is proposed in a NEW-VIEW message m in view $d_c.view$ and $m.justify$ contains a set M of $2f + 1$ VIEW-CHANGE messages for view $d_c.view$. Then p_i votes for d_c if (i) a wQC, a rQC or a sQC for d is provided by a replica in M , or (ii) for $f + 1$ messages in M , the *block* fields are all set to d . In either case, d has been voted by at least one correct replica. This completes the proof of claim (1).

(2) Based on claim (1), at least one correct replica p_i has voted for d_c . (i) If $d_c.view = d.view = v$, then d_c is proposed during normal case operation. According to ln

Algorithm 9: View change protocol for Dashing2

```
1 ▷ VIEW-CHANGE phase
2 as a new leader
3 //  $M$  is a set of  $n - f$  VIEW-CHANGE messages collected by
  the new leader
4  $(b', qc) \leftarrow \text{SAFEBLOCK}(M), b \leftarrow$ 
   $\text{CREATEBLOCK}(b', cview, cmd, qc)$ 
5 broadcast  $m = \langle \text{NEW-VIEW}, b, M \rangle$ 
6 // switch to normal case protocol
7 as a replica
8 wait for  $m = \langle \text{NEW-VIEW}, b, \pi \rangle$  from  $\text{LEADER}(cview)$ 
9  $b' \leftarrow b.parent, b_s \leftarrow b.stable, b_{gen} \leftarrow \text{QCBLOCK}(QC_r),$ 
10  $m \leftarrow \langle \text{GENERIC}, b, \perp \rangle$ 
11 if  $b'.view \geq cview$  or  $\text{rank}(b') \geq \text{rank}(b)$  or  $b.height \neq$ 
12  $b'.height + 1$  then
13   discard the message
14 if  $M \in \pi$ 
15    $(b_p, qc) \leftarrow \text{SAFEBLOCK}(M), m \leftarrow \langle \text{GENERIC}, b, \perp \rangle$ 
16   if  $b_p = b'$  and  $qc$  is a wQC or  $\perp$  and  $b.stable = b'.stable$ 
17   then send  $\text{QCVOTE}(m)$  to  $\text{LEADER}(cview)$ 
18   if  $b_p = b'$  and  $qc$  is a rQC or sQC and  $b.stable = b'$ 
19   then send  $\text{QCVOTE}(m)$  to  $\text{LEADER}(cview)$ 
20 // switch to normal case protocol
21 ▷ NEW-VIEW phase: switch to NEW-VIEW phase if  $\Delta_1$ 
  timeout occurs
```

18 and ln 21 of Algorithm 8, p_i has received a certificate (wQC, rQC, or sQC) qc_d for d before voting for d_c , where d and d_c are matching. (ii) Meanwhile, according to ln 18-23 of Algorithm 8, if $d.parent.view < v$, then p_i votes for d_c only if p_i has received a rQC or a sQC for d and $d_c.stable = d$. \square

Lemma C.2. Suppose that qc_b and qc_d are two qualified QCs, each is received by at least one correct replica. Let b and d be $\text{QCBLOCK}(qc_b)$ and $\text{QCBLOCK}(qc_d)$, respectively. If b and d are two conflicting blocks, then $\text{rank}(b) \neq \text{rank}(d)$.

Proof. Assume, on the contrary, that $\text{rank}(b) = \text{rank}(d)$. Let v denote the view of b and d . As each qualified QC consists of at least $2f + 1$ votes, at least one correct replica has voted for both b and d . Let b' and d' denote the parent block of b and d , respectively. Since a correct replica votes for at most one block with each height during normal case operation, at least one of b and d is proposed during view change. Therefore, $b'.view < v$ or $d'.view < v$. Now we consider two cases:

(1) $b'.view < v$ and $d'.view < v$. According to Algorithm 9, a correct replica p_i votes for at most one block that extends a block proposed in a lower view. Hence, b equals d .

(2) ($b'.view < v$ and $d'.view = v$) or ($b'.view = v$ and $d'.view < v$). If $b'.view < v$ and $d'.view = v$, then there exists a block d_0 with the lowest height on the branch led by d such that $d_0.view = v$. Hence, the view of $d_0.parent$ is lower than v . Let d'_0 denote a block on the branch led by d such that $d'_0.parent = d_0$. By Lemma C.1, at least one correct replica p_i has voted for d'_0 . According to ln 18-23 in Algorithm 8, p_i has received a rQC or a sQC for d_0 . Note that the view of $d_0.parent$ is lower than v . Then d_0 and b must be the same block according to case (1). Therefore,

d is an extension of b . The situation is similar to the case where $b'.view = v$ and $d'.view < v$.

In both cases, d and b are either the same block or on the same branch, contradicting the condition that they are conflicting blocks. Therefore, $\text{rank}(b) \neq \text{rank}(d)$. \square

Lemma C.3. If a correct replica has voted for d and set its vb to d , then d must be an extension of $d.stable$ and at least one correct replica has received a qualified QC for $d.stable$.

Proof. Let d_0 denote $d.parent$. Let p_i denote a correct replica that has voted for d and set its vb to d . According to ln 16-23 of Algorithm 8, p_i has received a certificate qc for d_0 , where qc and d are matching. We distinguish two cases.

(1) qc is a rQC or a sQC for d_0 and $d.stable = d_0$ (ln 21-23 in Algorithm 8). In this case, d is an extension of $d.stable$ and p_i received a qualified QC for $d.stable$.

(2) qc is a wQC for d_0 and $d.stable = d_0.stable$ (ln 18-20 in Algorithm 8). Let d_v denote the block with the lowest height on the branch led by d such that $d_v.stable = d.stable$. Let d'_v denote $d_v.parent$. Then $d_v.stable \neq d'_v.stable$. According to Lemma C.1, at least one correct replica p_j has voted for d_v . Since $d_v.stable \neq d'_v.stable$. Note p_j votes for d_v only if one of the following conditions holds: i) $d_v.stable = d'_v.stable$; ii) $d_v.stable = d'_v$ and p_i receives a qualified QC for d'_v . In this case, $d_v.stable = d.stable = d'_v$, d is an extension of $d.stable$, and p_j has received a qualified QC for $d.stable$.

Either way, d is an extension of $d.stable$ and at least one correct replica has received a qualified QC for $d.stable$. \square

Lemma C.4. If a qualified QC is formed in view v , then there exists only one block b with the lowest rank for which a qualified QC is formed in view v , and we have that:

- (1) the view of $b.parent$ is lower than v ;
- (2) if there exists a qualified QC for b_1 , $b_1.view = v$, and the view of $b_1.parent$ is lower than v , then b_1 equals b ;
- (3) if there exists a qualified QC for d and $d.view = v$, then d equals b or d is an extension of b .

Proof. If a qualified QC is formed in view v , then there exists only one block b with the lowest rank for which a qualified QC is formed in view v (according to Lemma C.2).

(1) Let b_v denote the block with the lowest height such that $b_v.view = v$ on the branch led by b . We have $b_v.height \leq b.height$ and the view of $b_v.parent$ is lower than v . If $b_v \neq b$, then there exists a block b'_v on the branch led by b such that $b'_v.parent = b_v$ and $b'_v.view = b_v.view = v$. From Lemma C.1, at least one correct replica p_i has received a rQC or a sQC for b_v . Thus, b_v is a block with a lower rank than b and a qualified QC for b_v is formed in view v , contradicting to the definition of b . Hence, we have $b_v = b$ and the view of $b.parent$ is lower than v .

(2) If there exists a qualified QC for b_1 , at least one correct replica has voted for both b_1 and b in view v . According to Algorithm 9, in view v , a correct replica only

votes for one block that extends a block proposed in a lower view than v . Therefore, it must hold that $b_1 = b$.

(3) There exists a qualified QC for d and $d.view = v$. Let d_0 denote the block with the lowest height on the branch led by d such that $d_0.view = v$. Then the view of the parent block of d_0 is lower than v . From Lemma C.1, a correct replica has received a qualified QC for d_0 . According to claim (2), we know d_0 equals b . Therefore, d equals b or d is an extension of b . \square

Lemma C.5. *For any qualified QC qc , if $QCBLOCK(qc) = b$ and $b.view = v$, then any block proposed in view v on the branch led by b has been voted by at least $f + 1$ correct replicas.*

Proof. Assume that block d is on the branch led by b such that $d.view = v$ and fewer than $f + 1$ correct replicas have voted for d . We immediately know that a qualified QC for d cannot be formed. Let d' denote a block such that $d'.parent = d$. So, a correct replica p_i votes for d' only if a wQC for d is received and p_i has voted for d . Since fewer than $f + 1$ correct replicas have voted for d , a qualified QC for d or any extensions of d (including b) cannot be formed (a contradiction). \square

Lemma C.6. *For any two qualified QCs qc_1 and qc_2 , let b_1 and b_2 be $QCBLOCK(qc_1)$ and $QCBLOCK(qc_2)$, respectively. If b_1 is conflicting with b_2 , then $b_1.view \neq b_2.view$.*

Proof. Assume, on the contrary, that $b_1.view = b_2.view = v$. Let b be the block with the lowest height for which a qualified QC was formed in view v . Then according to Lemma C.4, either b_1 or b_2 equals b or is an extension of b . Hence, $b_1.height \geq b.height$ and $b_2.height \geq b.height$. We consider three cases:

(1) If $b_1.height = b.height$ or $b_2.height = b.height$, then b_1 equals b or b_2 equals b . Therefore, b_1 and b_2 are the same block or they are on the same branch.

(2) If $b.height < b_1.height$, $b.height < b_2.height$, and $b_1.height = b_2.height$, then according to Lemma C.2, b_1 and b_2 must be the same block.

(3) If $b.height < b_1.height$, $b.height < b_2.height$, and $b_1.height \neq b_2.height$, then b_1 and b_2 are extensions of b . W.l.o.g., we assume that $b_1.height < b_2.height$. Let b'_2 denote a block on the branch led by b_2 such that $b'_2.height = b_1.height$. Then b'_2 is an extension of b and b'_2 and b_1 are blocks proposed during the normal case operation in view v . According to Lemma C.5, at least $f + 1$ correct replicas have voted for b'_2 . Since each rQC consists of at least $2f + 1$ votes, at least one correct replica has voted for both b'_2 and b_1 . Note that during the normal case operation, a correct replica votes for at most one block with each height. Therefore, it holds that b'_2 and b_1 must be either the same block or on the same branch.

In all cases, b_1 and b_2 are the same block or are blocks on the same branch, contradicting to the condition that they are conflicting blocks. Therefore, $b_1.view \neq b_2.view$. \square

Lemma C.7. *Suppose that all the correct replicas have voted for b in view v , $b.parent = b.stable$ and $b.parent$*

is proposed in view v . If a correct replica has received a wQC qc for d such that $rank(d.stable) \geq rank(b.parent)$, and d , $d.parent$, and $d.stable$ are blocks proposed in view v , then d equals b or d is an extension of b .

Proof. As b , $b.parent$, d , and $d.parent$ are all blocks proposed in view v , b and d are blocks proposed during normal case operation in view v . According to Algorithm 8, we know that if a correct replica has voted for d , the replica will set its vb to d at the same time. Since qc consists of $f + 1$ votes, at least one correct replica has voted for d . From Lemma C.3, d is an extension of $d.stable$ and at least one correct replica has received a qualified QC for $d.stable$. Now we consider two cases:

(1) $rank(d.stable) = rank(b.parent)$. Since $b.parent = b.stable$, any correct replica votes for b only after receiving a qualified QC for $b.parent$. Then $d.stable = b.parent$ and $d.height \geq b.height$ (according to Lemma C.2). Let d' denote the block on the branch led by d such that $d'.height = b.height$. Then at least one correct replica has voted for d' in view v according to Lemma C.1. Since correct replicas vote for at most one block with each height during normal operation in a view, d' must be equal to b . Therefore, d equals b or d is an extension of b .

(2) $rank(d.stable) > rank(b.parent)$. It is straightforward to see that $rank(d.stable) \geq rank(b)$. According to Lemma C.6, $d.stable$ is equal to b or $d.stable$ is an extension of b . Hence, d is an extension of b . \square

Lemma C.8. *For a commitQC qc for b and a qualified QC qc_d for d , if $rank(b) < rank(d)$, then d must be an extension of b .*

Proof. Let v denote $b.view$ and v_d denote $d.view$. As $rank(d) > rank(b)$, then $v_d \geq v$. Let b' denote $QCBLOCK(qc)$. Since qc is a commitQC for b , there are two conditions: (1) qc is a rQC for b' , $b'.stable = b'.parent = b$ and $b'.view = v$; (2) qc is a sQC for b , $b.parent = b.stable$ and the view of $b.parent$ equals v .

We prove the lemma by induction over the view v_d , starting from view v .

Base case: Suppose $v_d = v$. From Lemma C.6, for condition (1) or (2), d must be an extension of b .

Inductive case: Assume this property holds for view v_d from v to $v + k - 1$ for some $k \geq 1$. We now prove that it holds for $v_d = v + k$.

Let d_0 denote the block with the lowest height on the branch led by d such that $d_0.view = v_d$. Then the view of the parent block of d_0 is lower than v_d , d_0 is proposed during view change in view v_d , and d_0 is voted by at least one correct replica p_i (Lemma C.1).

Let m denote the NEW-VIEW message for d_0 . According to Algorithm 9, $m.justify$ is a set M of $2f + 1$ VIEW-CHANGE messages for view v_d . Let qc_1 denote the qualified QC with the highest rank contained in $M.justify$ and let b_1 denote $QCBLOCK(qc_1)$. For all the wQCs contained in $M.justify$, a correct replica chooses the wQC for a block with the highest stable block according to ln 19-24 in Algorithm 7 and sets the wQC as vc . Let b_0 denote

QCBLOCK(vc). Note that b_0 , $b_0.parent$ and $b_0.stable$ are proposed in the same view. Then b_0 is a block proposed during the normal case operation. Let b_2 denote the block which is included in more than $f + 1$ messages in M . If no such block exists, b_2 is set to \perp .

In view v_d , p_i votes for d_0 if $d'_0 = d_0.parent$, $d'_0.view < v_d$, $d'_0.height + 1 = d_0.height$ and one of the following conditions are satisfied:

- i) $d'_0 = b_2$, $rank(b_2.stable) \geq rank(b_1)$ (ln 24 in Algorithm 7).
- ii) $d'_0 = b_0$, i) is not satisfied and $rank(b_0.stable) \geq rank(b_1)$ (ln 25 in Algorithm 7).
- iii) $d'_0 = b_1$, i) and ii) are not satisfied (ln 26 in Algorithm 7)

Note that b_0 is a block proposed during the normal case operation in view $b_0.view$. Since a wQC consists of $f + 1$ votes, among which at least one is sent by a correct replica. Hence, at least one correct replica has voted for b_0 and sets its vb as b_0 . According to Lemma C.3, b_0 is an extension of $b_0.stable$ and at least one correct replica has received a qualified QC for $b_0.stable$.

Next, we prove the property holds in view $v + k$ for the two situations for $commitQC$, respectively.

(1) qc is a rQC. Let S denote the set of correct replicas who have received a qualified QC for b in view v . Since in view v correct replicas vote for b' only after receiving a qualified QC for b , we have $|S| \geq f + 1$. Note that a correct replica updates its QC_r only with a qualified QC with a higher rank. Thus, for any VIEW-CHANGE message sent by a replica in S , the *justify* field is set to a qualified QC with the same or a higher rank than b . Since M consists of $2f + 1$ messages, at least one message in M is sent by a replica in S . Therefore, $rank(b_1) \geq rank(b)$ and $b_1.view < v_d$.

According to the inductive hypothesis, b_1 must be equal to b or an extension of b . Therefore, if condition iii) is satisfied, d_0 must be an extension of b . If condition i) is satisfied, then $rank(b_2) > rank(b_1)$ and $rank(b_2.stable) \geq rank(b_1)$. Since at least one correct replica has set its vb to b_2 , then b_2 is an extension of $b_2.stable$ and a qualified QC qc_2 for $b_2.stable$ has been received by a correct replica from Lemma C.3. According to the inductive hypothesis, b_2 is an extension of b . Hence, d'_0 is an extension of b . If condition ii) is satisfied, then $rank(b_0.stable) \geq rank(b_1)$. Note that b_0 is an extension of $b_0.stable$ and at least one correct replica has received a qualified QC for $b_0.stable$. Thus, b_0 is an extension of b (according to the inductive hypothesis). Therefore, d'_0 is an extension of b . No matter which condition is satisfied, both d_0 and d must be extensions of d'_0 and extensions of b .

(2) qc is a sQC, the view of $b.parent$ equals v and $b.parent = b.stable$. Since qc consists of $3f + 1$ votes, all the correct replicas have received a qualified QC for $b.parent$, changed its QC_r to a qualified QC for $b.parent$, and voted for b in view v . Let V denote the set of correct senders of messages in M . It is clear that $|V| \geq f + 1$. Since correct replicas only change their QC_r to a qualified QC with a higher rank, we have $rank(b_1) \geq rank(b.parent)$.

(a) If $rank(b_1) \geq rank(b)$, then from Lemma C.2 and the induction hypothesis, b_1 is equal to b or b_1 is an extension of b . If condition iii) is satisfied, then d_0 and d are extensions of b . If condition i) or ii) is satisfied, at least one correct replica has voted for d'_0 and set its vb to d'_0 , and $rank(d'_0.stable) \geq rank(b_1)$. According to Lemma C.3, d'_0 is an extension of $d'_0.stable$ and at least one correct replica has received a qualified QC for $d'_0.stable$. Again, from the induction hypothesis, $d'_0.stable$ is equal to b or $d'_0.stable$ is an extension of b . Therefore, d_0 and d are extensions of b .

(b) If $rank(b_1) < rank(b)$, then $rank(b_1) = rank(b.parent)$. If $b_2 = b$, then condition i) is satisfied. Hence, d'_0 equals b and d_0 and d are extensions of b .

If $b_2 \neq b$, then there exists a correct replica p_i in V such that when p_i sent a VIEW-CHANGE message for v_d , its last voted block vb is b_e and $b_e \neq b$. Let b'_e denote $b_e.parent$. According to ln 18-20 in Algorithm 8, p_i has received a wQC qc_e for b'_e , $rank(b'_e) \geq rank(b)$, and $rank(b'_e) \geq rank(b.parent)$. If $b'_e.view = v$, then b'_e equals b or b'_e is an extension of b from Lemma C.7. If $b'_e.view > v$, then the view of $b'_e.stable$ is higher than v . From Lemma C.3, b'_e is an extension of $b'_e.stable$ and a correct replica has received a qualified QC for $b'_e.stable$. According to the inductive hypothesis, as $rank(b'_e.stable) > rank(b)$, it must hold that $b'_e.stable$ is an extension of b . Therefore, b_e must be an extension of b , b_2 is set to \perp or b_2 is an extension of b . If condition i) is satisfied, d'_0 equals b_2 . We know that p_i has sent qc_e in its VIEW-CHANGE message. Then $rank(b_1.stable) \geq rank(b.parent)$. If condition i) is not satisfied, condition ii) is satisfied and d'_0 equals b_1 . Note that a wQC for b_1 is included in M and b_1 is proposed during normal case operation. Similar to b'_e , b_1 must be an extension of b . Either way, d'_0 is equal to or an extension of b . Thus, d_0 and d are extensions of b .

Therefore, d must be an extension of b and the property holds in view $v + k$ based on Case (1) and Case (2). This completes the proof of the lemma. \square

Theorem C.1. (safety) *If b and d are conflicting blocks, then they cannot be both committed, each by at least a correct replica.*

Proof. Suppose that there exist $commitQC$'s for both b and d . According to Lemma C.1, a qualified QC must have been formed for both b and d . From Lemma C.2, if $rank(b) = rank(d)$, only one qualified QC for b and d can be formed in the same view. For the case where $rank(b) \neq rank(d)$, we assume w.l.o.g. that $rank(b) < rank(d)$. From Lemma B.7, we know that a qualified QC for d cannot be formed in view $d.view$. This completes the proof of the theorem. \square

Theorem C.2. (liveness) *After GST, there exists a bounded time period T_f such that if the leader of view v is correct and all correct replicas remain in view v during T_f , then a decision is reached.*

Proof. Suppose after GST, in a new view v , the leader p_i is correct. Then p_i can collect a set M of $2f + 1$ VIEW-CHANGE messages from correct replicas and broadcast a

new block b_v in a NEW-VIEW message m . Since $m.justify$ contains M , every correct replicas can verify the block b_v using function `SAFEBLOCK()` basing on input M .

Under the assumption that all correct replicas are synchronized in their view, p_i is able to form a QC for b and generate new blocks. All correct replicas will vote for the new blocks from p_i . Therefore a $commitQC$ for b can be formed by p_i and any correct replica will vote for b . After GST, the duration T_f for these phases to complete is of bounded length. \square

Appendix D. The Underlying BFT Protocol in Star

D.1. The Consensus Protocol Implemented in Star

We now describe the concrete atomic broadcast protocol that we implemented in Star. We use a variant of PBFT that differs from PBFT in two minor aspects. The protocol we will describe in the following is not presented in its general manner but instead takes as input the output from the transmission process.

Normal case operation. We first describe the normal case protocol.

Step 1: Pre-prepare. The leader checks whether $|W[le]| \geq n - f$. If so, it proposes a block B and broadcasts a $\langle \text{PRE-PREPARE}, v, B \rangle$ message to all replicas.

The block B is of the form $\langle v, cmd, height \rangle$, where v is the current view number, $B.cmd = W[le]$, and $B.height = le$. We directly use $B.height$ as the sequence number for B in the protocol.

Step 2: Prepare. Replica receives a valid PRE-PREPARE message for block B and broadcasts a PREPARE message.

After receiving a PRE-PREPARE message $\langle \text{PRE-PREPARE}, v, B \rangle$ from the leader, a replica p_j first verifies whether 1) its current view is v , 2) $B.cmd$ consists of at least $n - f$ wQC or rQC for epoch e , and 3) p_j has not voted for a block $B.height$ in the current view. Then p_j broadcasts a signed PREPARE message $\langle \text{PREPARE}, v, hash(B) \rangle$. The replica also updates its W queue if any QC included in $B.cmd$ is not in $W[B.height]$.

Step 3: Commit. Replica receives $n - f$ PREPARE messages for B and broadcasts a COMMIT message.

After receiving $n - f$ matching PREPARE messages with the same $hash(B)$, replica p_j combines the messages into a regular certificate for B , called a *prepare certificate*. Then p_j broadcasts a $\langle \text{COMMIT}, v, hash(B) \rangle$ message. After receiving $n - f$ COMMIT messages with the same $hash(B)$, p_j *a-delivers* B with sequence number le .

Note that the PRE-PREPARE step and the COMMIT step carry only $hash(B)$ as the message transmitted. The total communication for the normal case operation is thus $O(n^2\lambda)$ where λ is the security parameter.

Checkpointing. After a fixed number of blocks are a-delivered, replicas execute the checkpoint protocol for the garbage collection. Each replica broadcasts a checkpoint message that includes its current system state and the epoch

number for the latest a-delivered block. Each replica waits for $n - f$ matching checkpoint messages which form a stable checkpoint. Then the system logs for epoch numbers lower than the stable checkpoint can be deleted.

View change. We now describe the view change protocol. After a correct replica times out, it sends a VIEW-CHANGE message to all replicas. Upon receiving $f + 1$ VIEW-CHANGE messages, a replica also broadcasts a VIEW-CHANGE message. The new leader waits for $n - f$ VIEW-CHANGE messages, denoted as M , and then broadcasts a NEW-VIEW message to all replicas.

The VIEW-CHANGE message is of the form $\langle \text{VIEW-CHANGE}, \mathcal{C}, \mathcal{P} \rangle$, where \mathcal{C} a stable checkpoint and \mathcal{P} is a set of prepare certificates. For \mathcal{P} , a prepare certificate certificate for each epoch number greater than \mathcal{C} and lower than the replica's last vote is included.

The NEW-VIEW message is of the form $\langle \text{NEW-VIEW}, v + 1, c, M, \mathcal{PP} \rangle$, where c is the latest stable checkpoint, M is the set of VIEW-CHANGE messages, and \mathcal{PP} is a set of PRE-PREPARE messages. The \mathcal{PP} is computed as follows: For each epoch number e between \mathcal{C} and the epoch number of any replica's last vote, the new leader creates a new PRE-PREPARE message. If a prepare certificate is provided by any replica in the VIEW-CHANGE message, the PRE-PREPARE message is of the form $\langle \text{PRE-PREPARE}, v + 1, h \rangle$, where h is the hash in the prepare certificate. If none of the replicas provides a prepare certificate, the new leader creates a $\langle \text{PRE-PREPARE}, v + 1, B \rangle$, where B is of the form $\langle v + 1, W[e], e \rangle$.

Upon receiving a NEW-VIEW message, a replica verifies the PRE-PREPARE messages in the \mathcal{PP} field by executing the same procedures as the leader based on M . Then the replicas resume the normal operation.

D.2. A Star Variant

Star can be modified to support both wQC and rQC in the transmission process. The resulting protocol has a fast path for the consensus process: in the optimal case, we can reduce the number of phases from three to two. We now describe the variant of the protocol that has a fast path in the consensus protocol. The idea is to support both regular certificates and weak certificates in the transmission process.

In this variant, we modify the transmission process as follows. As in Algorithm 4, every replica additionally maintains a new local parameter rqc that is used to represent the latest rQC. We add the following procedures after Ln 6: upon receiving $2f + 1$ matching votes, replica p_i creates a rQC and updates its rqc accordingly. At Ln 4, a replica checks whether it has received a rQC for epoch $e - 1$. If so, it broadcasts a $\langle \text{PROPOSAL}, b, rqc \rangle$ message. Otherwise, it still broadcasts the $\langle \text{PROPOSAL}, b, wqc \rangle$ message.

Next, we modify the step 3 of the consensus protocol. If the proposed message B by the leader consists of n regular certificates, replicas can directly skip the commit step. Namely, after receiving $n - f$ matching PREPARE messages, replica p_j directly *a-delivers* B .

Now we describe the view change protocol. In the VIEW-CHANGE message, each replica additionally includes \mathcal{L} ,

a set of certificates for proposals. In \mathcal{L} , for any epoch number e between \mathcal{C} and the replica's last vote, $W[e]$ is included. After receiving $n - f$ VIEW-CHANGE message, the leader additionally executes the following procedure. For each epoch number of any replica's last vote, if a prepare certificate is provided, the PRE-PREPARE message includes the corresponding block. If the \mathcal{L} field in any VIEW-CHANGE messages consists of rQCs for proposals proposed in epoch e , the union of these rQCs will be packed in a block with a height e and broadcast in the PRE-PREPARE message. Otherwise, $W[e]$ is included.

Appendix E. Correctness of Star

Basing on the safety and liveness properties of the underlying atomic broadcast protocol in the consensus process, we now prove the correctness of Star.

According to the Star specification, a set V consisting of transactions in batches $\{\text{QCPROPOSAL}(qc_k)\}_{k \in [1..n-f]}$ delivered (in a deterministic order) by p_i must correspond to the set m (consisting of $n - f$ wQCs $\{qc_k\}_{k \in [1..n-f]}$) a-delivered by p_i from the underlying atomic broadcast protocol. In this case, we simply say V is associated with m .

We prove the safety of Star by showing that different sets of transactions cannot be committed together in the same epoch, each by a correct replica. We begin with the following lemma:

Lemma E.1. *If V_i associated with some m is delivered by p_i and V_j associated with the same m is delivered by p_j , then we have $V_i = V_j$.*

Proof. Assume, towards a contradiction, that $V_i \neq V_j$. Let $\{qc_k\}_{k \in [1..n-f]}$ denote the $n - f$ wQCs contained in m . Then we have that V_i is a union of transactions in proposals $\{b_k\}_{k \in [1..n-f]}$, where $b_k = \text{QCPROPOSAL}(qc_k)$. Similarly, V_j is a union of transactions in proposals $\{b'_k\}_{k \in [1..n-f]}$, where $b'_k = \text{QCPROPOSAL}(qc_k)$. Since $V_i \neq V_j$, we have that there exists $k \in [1..n-f]$ such that $b_k \neq b'_k$. Note that qc_k is a wQC for b_k and also a wQC for b'_k . Since $b_k \neq b'_k$, this violates the unforgeability of digital signatures (or threshold signatures). \square

Now we are ready to prove safety.

Theorem E.1. *(safety) If a correct replica delivers a transaction tx before delivering tx' , then no correct replica delivers a transaction tx' without first delivering tx .*

Proof. Suppose that a correct replica p_i delivers a transaction tx before delivering tx' . Let L_i denote the a-delivered messages log of p_i and TL_i denote the delivered transactions log of p_i . For any correct replica p_j , let L_j denote the a-delivered messages log and TL_j denote the delivered transactions log of p_j . According to the safety of the consensus protocol, either L_i equals L_j or one of L_i and L_j is an an prefix of the other. Note that TL_i and TL_j

contains transactions associated with messages in the a-delivered messages logs in a deterministic order. According to Lemma E.1, either TL_i equals TL_j or one of TL_i and TL_j is an prefix of the other. This completes the proof of the theorem. \square

Theorem E.2. *(liveness) If a transaction tx is submitted to all correct replicas, then all correct replicas eventually deliver tx .*

Proof. If a transaction tx is submitted to all correct replicas, eventually in some epoch, tx is included in the proposal by at least one correct replica. Using the strategy in EPIC (following HoneyBadgerBFT), eventually the wQC wqc for the proposal containing the transaction tx will be sent to the consensus process.

At least $n - f$ wQCs will be a-delivered in the consensus process, and at least $f + 1$ wQCs must be proposed by correct replicas. So there is some probability that wqc for tx will be delivered. If the corresponding transaction has been received by a correct replica, then we are done. Otherwise, a correct replica just needs to run the fetch operation to get the corresponding proposal containing tx . Recall the use of wQC ensures that a correct replica must have stored the corresponding proposal. (If the underlying atomic broadcast only achieves consistency rather than agreement, then we can still the standard state machine replication mechanism such as state transfer to ensure all correct replicas deliver the transaction.) \square

Appendix F. Correctness of the Star Variant

We prove the correctness of the Star variant as described in Appendix D.2. For safety, we prove that the consensus process is safe within a view and across views. For liveness, we prove that after GST, a correct primary is able to lead all the replicas to reach an agreement.

Lemma F.1. *If B_1 and B_2 are different blocks that are proposed with the same epoch number in the same view and a prepare certificate is formed for both blocks, then $B_1 = B_2$.*

Proof. We prove the lemma towards contradiction by assuming $B_1 \neq B_2$. Let v denote the view in which B_1 is proposed. As a valid prepare certificate consists of $2f + 1$ partial signatures, at least one correct replica has sent a PREPARE message for both B_1 and B_2 in view v . However, a correct replica votes for at most one block with a specific height in view v , a contradiction. \square

Lemma F.2. *If a one correct replica p_i has a-delivered block B_1 in view v with epoch number e , another correct replica has a-delivered a block B_2 in view v' with epoch number e such that $v' > v$, then $B_1 = B_2$.*

Proof. If p_i has a-delivered B_1 , it has received $2f + 1$ matching COMMIT messages (let the set of replicas be S_1), among which at least $f + 1$ are sent by correct replicas.

Any of the $f + 1$ correct replicas have received a prepare certificate for B_1 . As $v' > v$, we consider the NEW-VIEW message in view v' . As a valid NEW-VIEW message consists of $2f + 1$ VIEW-CHANGE messages (let the set of replicas be S_2), S_1 and S_2 has at least one correct replica p_i in common. According to the view change rules, replica p_i will include a prepare certificate for B_1 in its VIEW-CHANGE message. However, the leader in view v' has not received such a message so the leader proposes B_2 , a contradiction.

Note that correctness holds even if a fast path occurs. During a fast path, a block B_1 with epoch number e consists of n rQCs. After receiving a prepare certificate for B_1 , a correct replica p_i a-delivers B_1 directly. In this case, p_i knows that at least $f + 1$ correct replicas stores n rQCs for epoch number e . For any of the correct replicas, n rQCs will be included in VIEW-CHANGE messages in the \mathcal{L} field. If in view v' , a replica a-delivers B_2 , a prepare certificate is formed. In other words, a correct replica has received n rQCs (for B_1) but has not sent it to the leader during the view change, a contradiction. \square

As every block is a-delivered in order according to the epoch number of the delivered block, We prove safety for the consensus by proving the following theorem:

Theorem F.1. (safety) *If a correct replica a-delivers a message m before a-delivering m' , then no correct replica a-delivers a message m' without first a-delivering m .*

Proof. Correctness in the same view follows from Lemma F.1 and correctness across views follows from Lemma F.2. That completes the proof. \square

Theorem F.2. (liveness) *If a correct replica a-broadcasts a message m , then all correct replicas eventually a-deliver m .*

Proof. We consider two cases: a correct replica a-broadcasts a message m in the normal case protocol; a correct replica a-broadcasts a message m after view change. Correctness of the first case follows from the fact that all messages will be received after GST. We now show the correctness of the second case. After GST, a correct replica p_i is able to collect a set M of $n - f$ VIEW-CHANGE message for view v and broadcasts a NEW-VIEW message with a proposal m . Any PRE-PREPARE message included in the NEW-VIEW message includes either the hash of a block such that a prepare certificate is provided in the NEW-VIEW message, or $W[e]$, a set of wQCs. As prepare certificates and the wQCs/rQCs in $W[e]$ can be verified by any correct replica, then the proposal from p_i can be verified. Accordingly, any correct replica can then resume normal case operation and eventually a-deliver m . \square